

# BURY EasyTouch



## Index

<b>Introductory information</b>	<b>2</b>
1. General	2
2. Security guidelines	3
<b>Installation of the system</b>	<b>6</b>
3. Scope of supply	6
4. Instructions on battery	8
5. Positioning and mounting	9
<b>First steps</b>	<b>12</b>
6. Using the hands-free car kit for the first time	12
7. Establishing a <i>Bluetooth</i> connection	13
<b>Operating guidelines</b>	<b>15</b>
8. Accepting, making, ending calls	15
9. Other operating options	19
<b>Further Information</b>	<b>22</b>
10. Service	22
11. Appropriate use of this system	23
12. Approvals and declaration of conformity	24

## 1. General

### **Dear customer,**

Congratulations on purchasing a BURY hands-free car kit. You have chosen a high quality product that is extremely easy to use.

Please read the operating manual carefully so that you can fully enjoy your BURY hands-free car kit. If you have any further questions concerning installation or operation of your car kit, please contact your dealer. He will be happy to give you reliable advice.

You can also contact our hotline. Our phone and fax numbers are listed in the chapter Service at the end of the operating instructions.

### **Have a good trip!**

## 2. Security guidelines

### **Installation - who and where**

The installation of this system can be carried out by yourself but please observe any installation requirements issued by the automotive manufacturer. During the installation, park the car at a place where the road traffic is not impaired.



### **Power supply**

This hands-free car kit is designed for use in vehicles independent of the available power supply, whether 12 or 24 volts. The system's battery can, however, be charged from both power networks via the cigarette lighter plug (car and HGV). The supply voltage is appropriately adjusted.

### **Exclusion of Liability:**

Please comply with the laws and regulations concerning the e-certification and the use and installation of electronic systems in vehicles which are particular to your country. If you do not know these, please inform yourself of them appropriately. In case of doubt, only charge the battery of the hands-free car kit using the car cigarette lighter plug when the vehicle is stationary. Please do not hesitate to call our hotline if you have any questions concerning these matters.

## Position, volume

Install the components of the device in the vehicle so that your field of vision is not impaired and the components are not mounted in the impact zone of the passenger compartment or in the airbag inflation zones.



## Intended use

We shall not be liable for damages or malfunctions due to improper use of the hands-free system. Therefore, do not expose the device to moisture, extreme temperatures or shocks and carefully follow the procedure described in the installation and operating guidelines.



## Use while driving

Operate the system only when the situation allows it and when you do not endanger, harm, constrain, or annoy other road users. The volume of the device has to be set in a way that exterior noise is still audible.

## Faults

Do not commission the device if you detect or assume a defect. In this case, contact a Bury specialised dealer or our hotline. Improper repair efforts can be dangerous for you. Therefore, only skilled personnel may perform inspections.

**Important:**

- ▶ The driver is ultimately responsible for the safe operation and control of their vehicle at all times. You should never use a hand held phone, including sending or reading text or picture messages, while driving.
- ▶ Research indicates that there is a risk to safety when the driver of a motor vehicle is distracted and using a mobile phone while driving can be a distraction.
- ▶ The manufacturer strongly recommends that you use a hands-free solution for making telephone calls whilst driving.

### 3. Scope of supply

①

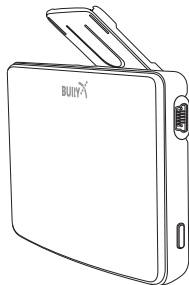

②

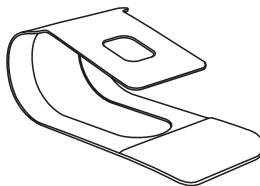

③

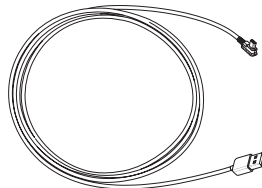

④

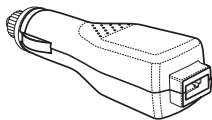

⑤



⑥



The hands-free car kit (HFCK) is supplied with various components depending on the sales region. However, the operating instructions apply to all variants.

**Description of the components:**

- 1) Hands-free car kit
- 2) Sun visor clip
- 3) Mini USB / USB cable
- 4) 12V/24V Cigarette lighter plug
- 5) Detailed operating instructions are available in the internet
- 6) Printed quick user guide

**Note:**

► If certain components are added or omitted you will receive the corresponding information on a separate enclosure.

The BURY EasyTouch hands-free car kit has touch keys, an integrated battery, an on-off switch on the right side, a mini USB port on the right side, a locking device for the sun visor clip and an integrated, pull-out microphone.

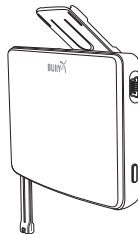

## 4. Instructions on battery

The hands-free car kit (HFCK) has an integrated rechargeable battery which remains activated for approx. **350 hours** when fully loaded. The battery guarantees up to **7 hours** of hands-free talking without the need for recharging. These values may differ depending on the settings and the use of the hands-free car kit.

Please avoid charging the battery inside the vehicle in direct sunlight and the high interior temperatures which can rapidly be reached in parked vehicles. In such cases, please remove the HFCK and place it either in the door glove pocket or the glove box.

### **Please comply with the following temperature levels:**

- Storage between -20 and +60 degrees Celsius
- Charging between 0 and +45 degrees Celsius
- Use between -20 and +60 degrees Celsius

If you do not comply with these temperature levels then the battery can get damaged and then it is possible that the HFCK will fail to work.



## 5. Positioning and mounting

### Mounting on the sun visor

Depending on how you would like to attach the HFCK to the sun visor in the vehicle, you must slide the sun visor clip onto the locking device on either side. Press the fastener on the locking device to completely slide in the sun visor clip. The clip snaps into place with a click sound, as long as it has been correctly slid into place.

### Variant A:

**Push the sun visor clip upwards and away from you onto the sun visor.**

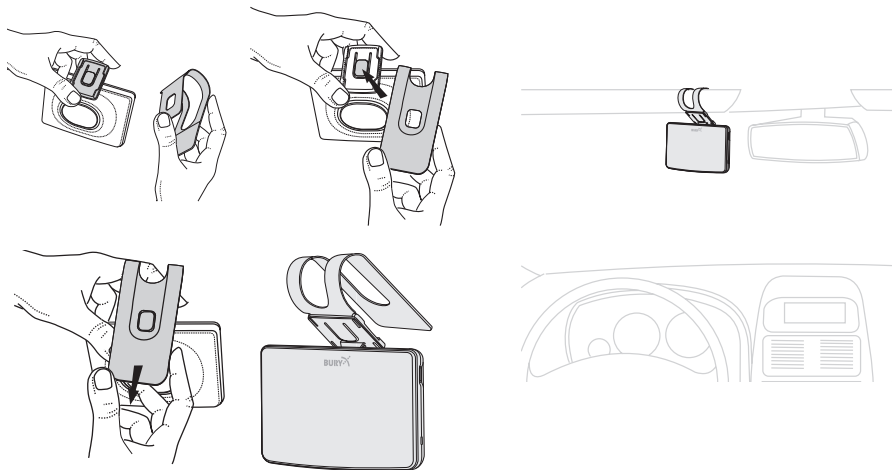

**Variant B:**

Push the sun visor clip downwards and towards you onto the sun visor.

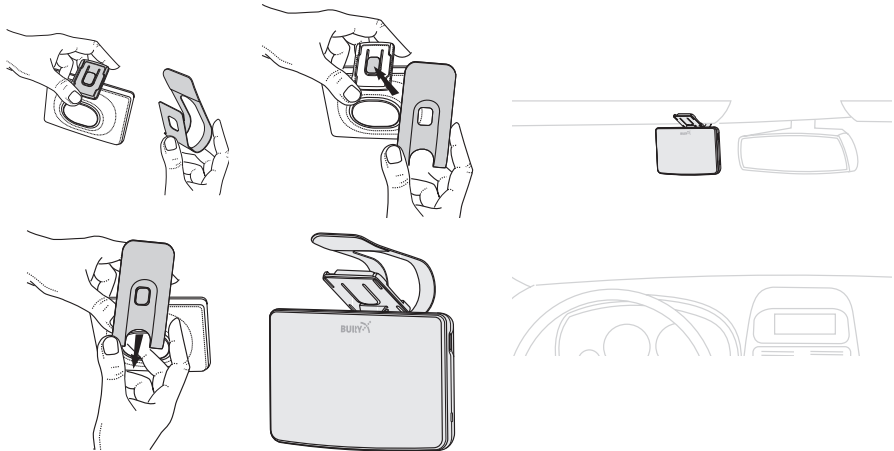
**Pulling out the microphone**

Now pull out the integrated microphone from the hands-free car kit for optimal speech input.

## Opening and shutting the sun visor

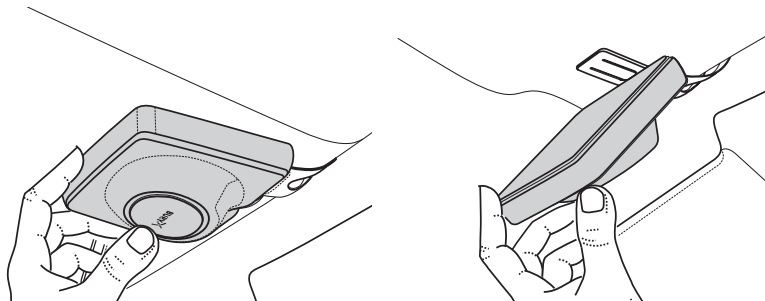

**Note:**

- ▶ Flipping down the sun visor does not effect the function of the HFCK.
- ▶ The sun visor can sometimes not be fully opened.

Depending on the type / thickness of the sun visor, you should try both installation types once. Check whether the system can be used comfortably and that it does not restrict your view of the road.

To disconnect the clip from the locking device, press down the fastener and then remove the clip.

**Power supply**

Connect the BURY EasyTouch via the USB cable to the cigarette lighter plug and plug this into the corresponding connection inside the car.

**Charging the BURY EasyTouch battery**

**Option 1:** Charge the BURY EasyTouch battery via the USB cable and the cigarette lighter plug inside the car.

**Option 2:** Charge the BURY EasyTouch battery via the USB cable on your PC / laptop.

## 6. Using the hands-free car kit for the first time

Turn on the device using the on-off button on the right side. The BURY EasyTouch telephone list is empty, automatic connection is turned off. The device says: **Choose language**. The device reads out the available languages in the national language. Press one of the buttons to select the desired language. The language is loaded. The list of the languages available is read out three times. If you do not choose a language, English is automatically selected.

Then link your mobile phone to BURY EasyTouch. If a telephone has been linked to BURY EasyTouch the device says: **Phone is connected**.

## 7. Establishing a *Bluetooth* connection

If you wish to establish a *Bluetooth* connection between your mobile and the HFCK for the first time, you have to activate the Bluetooth function of your mobile phone and search for *Bluetooth* devices. In this case, search for a device labelled „BURY EasyTouch“. If several devices were identified, please select the HFCK and enter the **PIN number „1234“**. The *Bluetooth* connection (pairing) will then be established between your mobile phone and the HFCK. It is possible that you will also have to click on ‚connect‘ or ‚allow data transfer‘ on your mobile phone if you want to be able to make a connection.

If it is not possible to establish a connection, please check and update the software release (firmware) of your mobile phone or of the HFCK. You will find an overview dealing with this subject on the Internet at [www.bury.com](http://www.bury.com).

In addition it is possible that you must delete all devices connected to your mobile phone first in order to enable a correct identification of the HFCK and the establishment of a connection.

### **Note:**

- ▶ If the rechargeable battery of the mobile phone is low, it is sometimes not possible to establish a *Bluetooth* connection.
- ▶ In the internet you can find an overview with a large number of mobile telephones which have been tested with this hands-free car kit. Please note, however, the use of firmware which deviates from the list and is installed on a listed mobile telephone can lead to the fact that certain displays and functions are no longer possible or only possible to a limited extent.

If you wish to cancel a *Bluetooth* connection, you can either disconnect it conveniently at the HFCK or at your mobile phone. In addition, the connection is disconnected, if you move too far away from the vehicle while taking your mobile phone with you and thus leave the reception radius of the HFCK. If you return to your vehicle within 15 minutes, your telephone will be automatically reconnected to BURY EasyTouch.

Please note that the capacity of your mobile phone's storage battery can quickly decrease when the *Bluetooth* function is active. If you do not want to use the Bluetooth function anymore, e.g. if you leave the vehicle for a longer period, it is recommended to deactivate this function.

The HFCK has a memory for the storage of the identification of up to 8 mobile phones. In case a ninth mobile phone is connected, the oldest entry in the HFCK memory will be cancelled.

If you have changed some settings and the HFCK does not function as you would like since, you can reset the HFCK to factory status.

## 8. Accepting, making, ending calls

The BURY EasyTouch is operated using the key buttons on the device. The function of the buttons can vary according to the menu item.

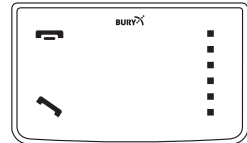

**Note:**

► Please comply with the country-specific laws concerning in-car telephone calls.

### Making calls

Press the call button. The device says: **Enter voicetag**. Give your voicetag loud and clearly.



Your BURY EasyTouch offers you three ways of using voicetags:

## Option 1: Creating and using voicetags

To make a phone call you must set voicetags on your mobile phone. You can only set voicetags on your mobile phone for contacts already saved in your address book (not on your SIM card!).

### **Please note:**

► Copy your contacts from your SIM card into your telephone address book. Then only use contacts from your address book.

When you call up a contact from your address book, choose under Options „Add call name“. The menu item depends on the manufacturer and may have another name. In this menu you can set, change or delete the voicetag for a contact. You can find further information in the operating instructions for your mobile phone.

In your address book you can see which contacts you have already saved a voicetag for. A symbol is shown behind the name. This varies depending on your mobile phone but is usually a Pacman.

## Option 2: Reading out the phonetics

For some mobile phones, you can open up the mobile phone directory by pressing down the BURY EasyTouch call button. The device says: **Enter voicetag**. The voicetag you enter (contact name) is compared with the contacts saved in the mobile phone directory using phonetic technology and selected if there is a match.



### Option 3: Using your smartphone's voice dialling function

Most smartphones have a voice dialling function which you can activate using BURY EasyTouch. You can then use your smartphone's voice dialling function via BURY EasyTouch.



Please make sure that you repeat the smartphone's precise voicetag which you can find in the your smartphone's operating instructions. Using the voicetag, in addition to making calls you can also play music via BURY EasyTouch.

#### Tip:

- ▶ You can only stop the music play back via your smartphone.
- ▶ In the event of incoming and outgoing calls, the music play back will be automatically interrupted.

If you press the call button on the BURY EasyTouch, the device says: **Enter voicetag**. Some smartphones may then release a signal sound after one to three seconds. Only then can you enter the voicetag.



### Outgoing call

Briefly press down on the call button to activate the voicetag function. The device says: **Enter voicetag**. Begin the call with a voicetag. If the number dialled is busy, you can begin to redial. To do so, hold down the call button (for two seconds). The device says:



### Redial.

If you announce a non-saved voicetag then the device says: **Voicetag is not available**. BURY EasyTouch returns to standby mode.

Briefly press down on the end call button to end the voicetag function, the active call or the redialling.



If you make a call and briefly press down on the call button, the private mode is then started. The call is then forwarded to the mobile phone.



### Incoming call

The backlight to the sensor keys is activated. In addition to this, a ring tone sounds which alerts to an incoming call. If the mobile phone transfers its own ring tone to the hands-free car kit (depending on the mobile phone), then this will sound. If the caller has hidden their number, then the device says: **Unknown caller**.



Briefly press down on the end call button to refuse the call. The device returns to standby mode.



Briefly press down on the call button to accept the incoming call.

### Setting the volume

Press down the vertical buttons to gradually increase (top buttons) or decrease the sound (lower buttons) the sound during an active conversation. A high signal tone sounds when the maximum volume has been reached. A low signal tone sounds when the minimum volume has been reached.



But you can also go over the buttons with your fingers (both directions).

## 9. Other operating options

### Connecting a telephone

At least one telephone is listed in the BURY EasyTouch telephone list. Automatic connection is on and the last connected telephone is searched for three times, each attempt lasts 5 seconds. If this telephone is not found, the next telephone in the list is searched for (for 5 seconds). After this, the list is searched through entirely three times before the automatic connection is interrupted. The device then returns to standby mode. Eight telephones can be linked. If a ninth telephone is linked, the last telephone in the list is deleted (first in/first out). The last telephone connected is always in first position on the list.

While already linked phones are searched for by BURY EasyTouch, you cannot link and connect any other telephone yourself.

To link and connect another mobile phone, briefly press down the end call button to interrupt the automatic connection.

Hold down (for five seconds) the end call button to reload the factory settings. The device then switches off.



Press down on the call button to start the automatic connection.



### **Disconnecting a telephone**

Hold down (for three seconds) the end call button to disconnect the telephone. The device says: **No phone connected.**



### **Standby mode**

After 30 seconds the BURY EasyTouch light goes off. Press down on the aim point, to return to active status.

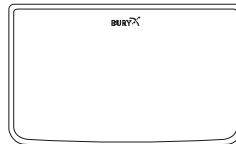

## Voice messages in standby mode

The following voice messages are only played back in standby mode but not during a call or during active functions. The volume is the same as during an active telephone call.



### Status:

Battery status below 10 %:

System charging:

Battery is 100 % charged:

USB cable removed:

### The device says:

**Low battery level** (repeated every five minutes)

**Charging on**

**Battery is full**

**Charging off**

## Load factory settings

Hold down the end call button (for five seconds) to load the factory settings. The device then turns itself off.



## Turning off BURY EasyTouch

The device turns itself off after thirty minutes if no telephone is connected. If you would like to switch the device off beforehand, simply move the on-off button to the right.

## 10. Service

In case of general or technical queries, suggestions and comments, please do not hesitate to contact our team at any time. Suggestions and feedback are always welcomed:

**Administration:**

**BURY GmbH & Co. KG**  
**Robert-Koch-Straße 1-7**  
**D-32584 Löhne**  
**GERMANY**

**Producer:**

**BURY Spółka z o.o.**  
**ul. Wojska Polskiego 4**  
**39-300 Mielec**  
**POLAND**

Hotline: +49(0)180 5 - 842 468\*

Faxline: +49(0)180 5 - 842 329\*

\* 0.14 €/min. Deutsche Telekom AG landline

the costs of international telephone calls which are made from abroad can vary.

E-Mail: [hotline@bury.com](mailto:hotline@bury.com)

**Warranty / Service desk:**

The duration of the warranty for the components of this product totals two years subsequent to the date of sale to the end customer. Any warranty claims you may have as an end customer are to be asserted towards your contractual partner. If the corresponding contractual partner is not able to rectify a corresponding fault, please exercise your rights of purchase. If subsequent to agreement with your contractual partner the product is to be sent directly to the manufacturer, then please send it, along with a detailed description of the fault in the German or English language and a copy of the proof of purchase, directly to our service team:

---

**BURY GmbH & Co. KG**  
**Im Hause DPD Depot 103**  
**Robinienweg**  
**D-03222 Lübbenau**  
**GERMANY**

### **Information on the disposal of electrical goods in the EU**

The crossed out wheelee bin symbol means that electrical and electronic products, batteries and accumulators must be disposed of separately in the European Union. Please do not dispose of any such products in your normal household waste. As the owner of a product of this sort you are legally obliged to dispose of it at your local dumping site or recycling centre, where you are able to leave your waste electrical goods free of charge.

## **11. Appropriate use of this system**

This hands-free car kit is only intended for use with Bluetooth mobile telephones in motor vehicles. When using this system, please comply with the regulations and laws specific to the country in which you are driving and the instructions provided in the guidebook for the mobile telephone that you are using.

## 12. Approvals and declaration of conformity

Purchase and production as well as service and sales at BURY are subject to tough quality and environmental management conditions according to ISO 9001 and ISO 14001. The system has



the CE approval pursuant to the R&TTE 1999/5/EC regulation



The hands-free device cigarette lighter plug has e1 type approval pursuant to guideline 2009/19/EC „Electromagnetic compatibility in vehicles“

You can request a conformity declaration from the manufacturer of this product by post under the manufacturer's address which is stated above, or by writing to the following email address:

ce\_conformance@bury.com

Please provide your email request in either English or German.

Version 05/2011

25.1342.0-01-300511

Errors and omissions excepted.

The *Bluetooth*® word brand and the *Bluetooth*® logos are owned by Bluetooth SIG, Inc.

All use of these brands by BURY Technologies takes place within the scope of the corresponding licence. All of the other stated brands are owned by their corresponding owner.

© 2011 by BURY. All rights reserved.



