

Montageanleitung

LED Tagfahrlicht/Positionslicht

Mounting instructions

LED Daytime Running Lights/parklight

Instructions de montage

LED Feux diurnes/feux de position

Monteringsanvisning

LED Varselljus/parkeringsljus

Montagehandleiding

LED Dagriflichten/positielicht

Instrucciones de montaje

LED Luces de marcha diurna/luz de posición

Instruzioni di montaggio

LED Luci di marcia diurna/luce di posizione





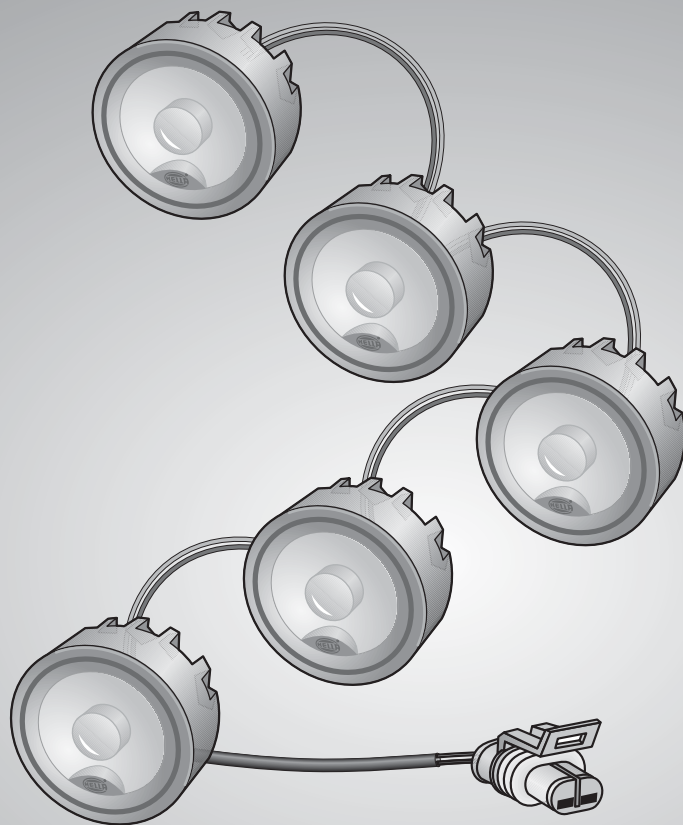





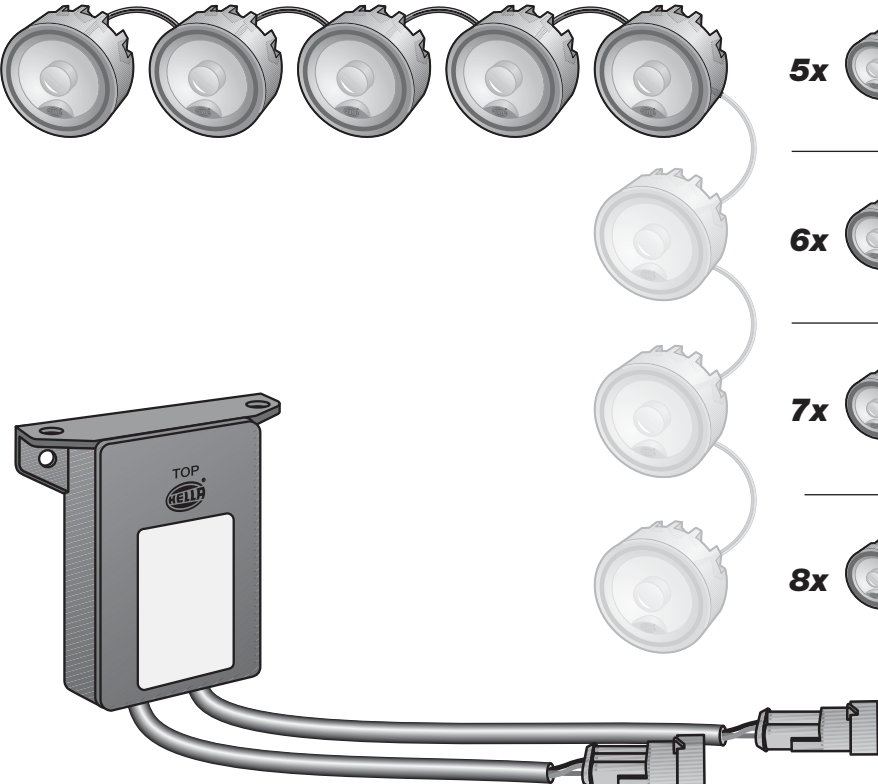







Asennusohjeet

LED Huomiovalo/Äärivalo



LEDay Flex



Lieferumfang Kit includes	Fourniture Leveransomfattning	Inhoud set Volumen del suministro	Dotazione die fornitura Osaluuttelo	
		5x 	  + 	2PT 010 458-801 2PT 010 458-811
		6x 	  + 	2PT 010 458-821 2PT 010 458-831
		7x 	  + 	2PT 010 458-841 2PT 010 458-851
		8x 	  + 	2PT 010 458-861 2PT 010 458-871

Zubehör
(nicht im Lieferumfang enthalten)
Accessories (not included with kit)

Accessoires (non fournis)
Tillbehör (ingår ej i leveransen)

Toebehoren (worden niet meegeleverd)
Accesorios (no se incluyen en el suministro)

Accessori (non in dotazione)
Lisätarvikkeet
(eivät kuulu toimitukseen)

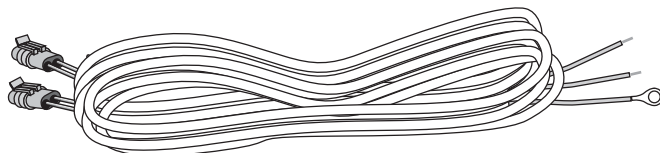

8KA 165 959-001

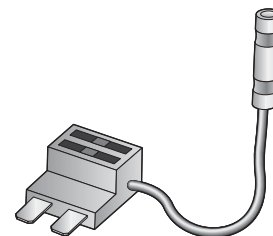

Mini 8JD 743 557-801
ATO 8JD 743 557-811

8KW 744 807-801



8KB 178 139-002

500 mm



Benötigtes Werkzeug
Tools required

Outillage nécessaire
Nödvändiga verktyg

Noodzakelijk gereedschap
Herramientas necesarias

Utensili necessari
Tarvittavat työkalut

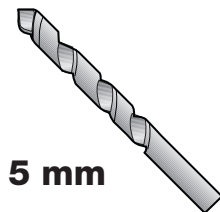
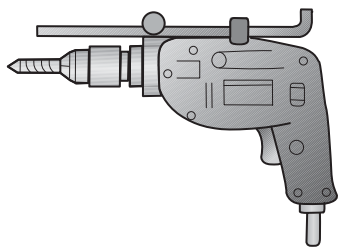
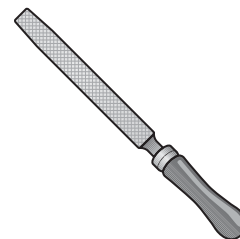
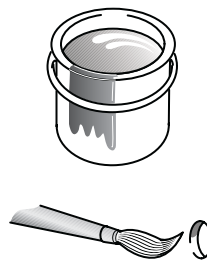
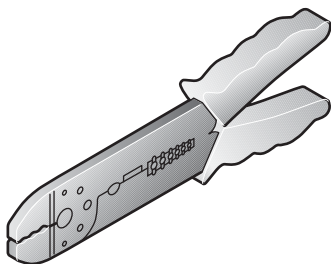
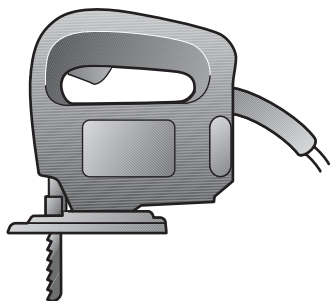

5 mm

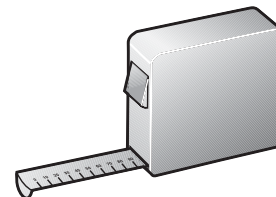
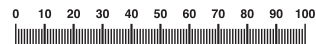
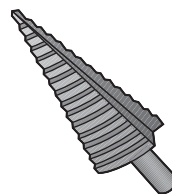



Tagfahrlicht
 Daytime Running Lights
 Feux diurnes
 Varselljus
 Dagrijlichten
 Luces de marcha diurna
 Luci di marcia diurna
 Huomiovalot

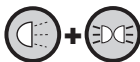

Tagfahrlicht/Positionslicht
 Daytime Running Lights/parklight
 Feux diurnes/feux de position
 Varselljus/parkeringsljus
 Dagrijlichten/positielicht
 Luces de marcha diurna/luz de posición
 Luci di marcia diurna/luce di posizione
 Huomiovalot/Äärivalo



Gilt für
 Applies to
 S'applique à
 Gäller
 Geldt voor
 Se aplica a
 Si applica a
 Pätee

Montage Mounting

Montage général Montering

Mantage Montaje

Montaggio Asennus

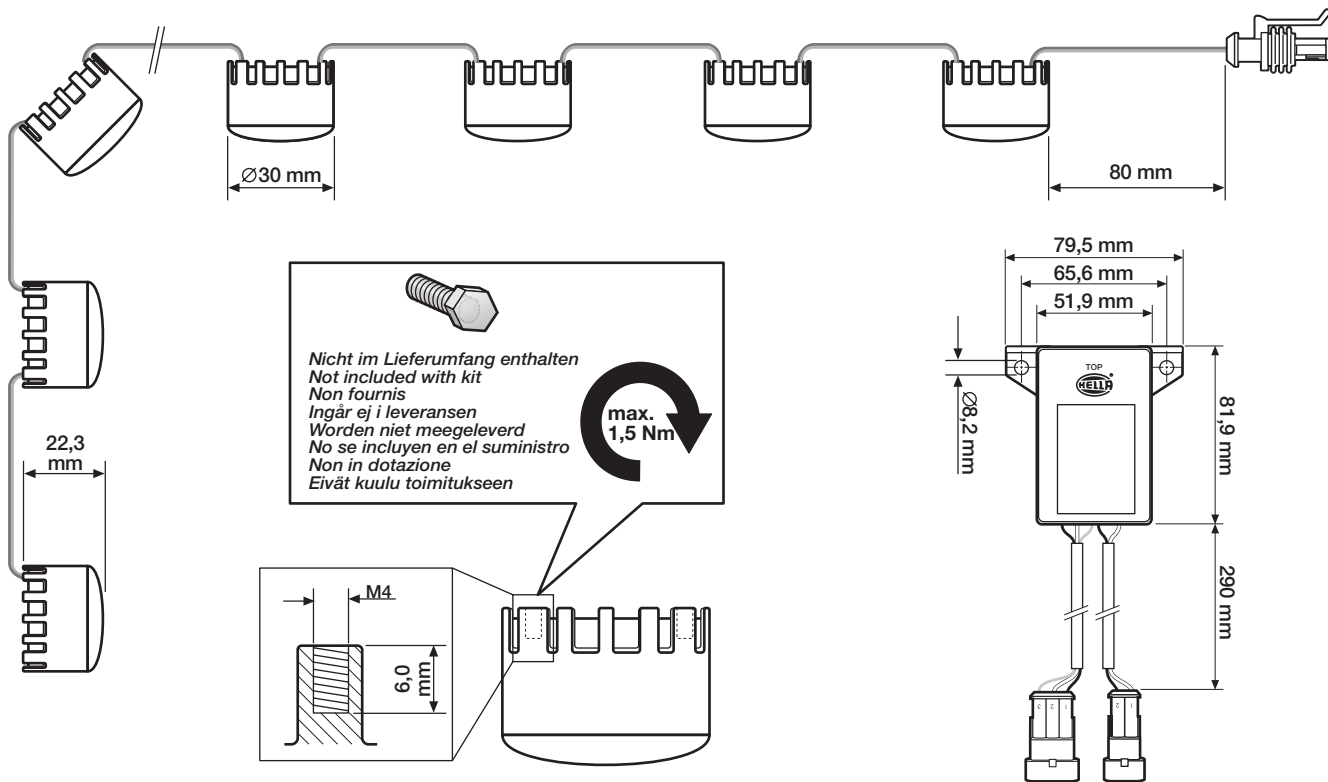

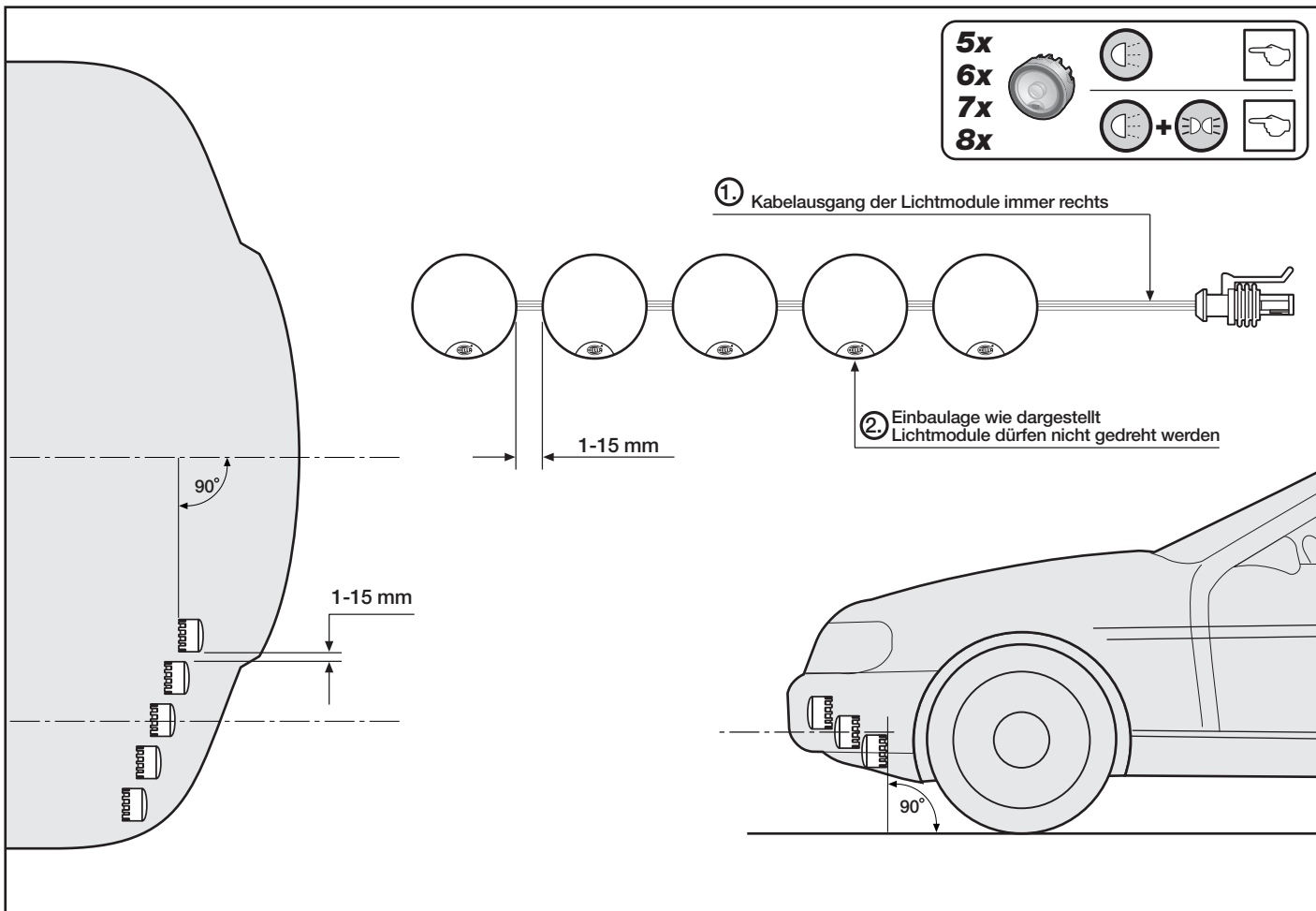

- DE** ① Kabelausgang der Lichtmodule immer rechts.
② Einbaulage wie dargestellt. Lichtmodule dürfen nicht gedreht werden.

- EN** ① Cable exit of the light modules always to the right.
② Mounting position as illustrated. Light modules are not to be rotated.

- FR** ① Sortie de câble des modules d'éclairage toujours à droite.
② Position de montage comme illustré. Ne pas tourner les modules d'éclairage.

- SV** ① Ljusmodulernas kabelutgång är alltid till höger.
② Monteringsläge enligt bild. Ljusmodulerna får inte vridas.

- NL** ① Kabeluitgang van de lichtmodule altijd rechts.
② Inbouwpositie zoals weergegeven. Lichtmodules mogen niet gedraaid worden.

- ES** ① Salida del cable de los módulos lumínicos siempre a la derecha.
② Posición de montaje tal como se muestra. No se pueden girar los módulos lumínicos .

- IT** ① Uscita cavo dei moduli luminosi sempre a destra.
② Posizione di montaggio come illustrato. I moduli luminosi non devono essere ruotati.

- FI** ① Valomoduulien kaapelilähtö aina oikealla.
② Asennus kuten kuvattu. Valomoduuleja ei saa kääntää.

5x



2PT 010 458-801



13

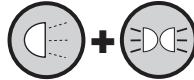

2PT 010 458-811



17

6x



2PT 010 458-821



13

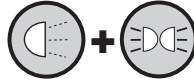

2PT 010 458-831



18

7x



2PT 010 458-841



13

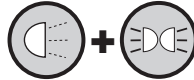

2PT 010 458-851



19

8x



2PT 010 458-861



13

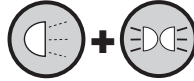

2PT 010 458-871



20

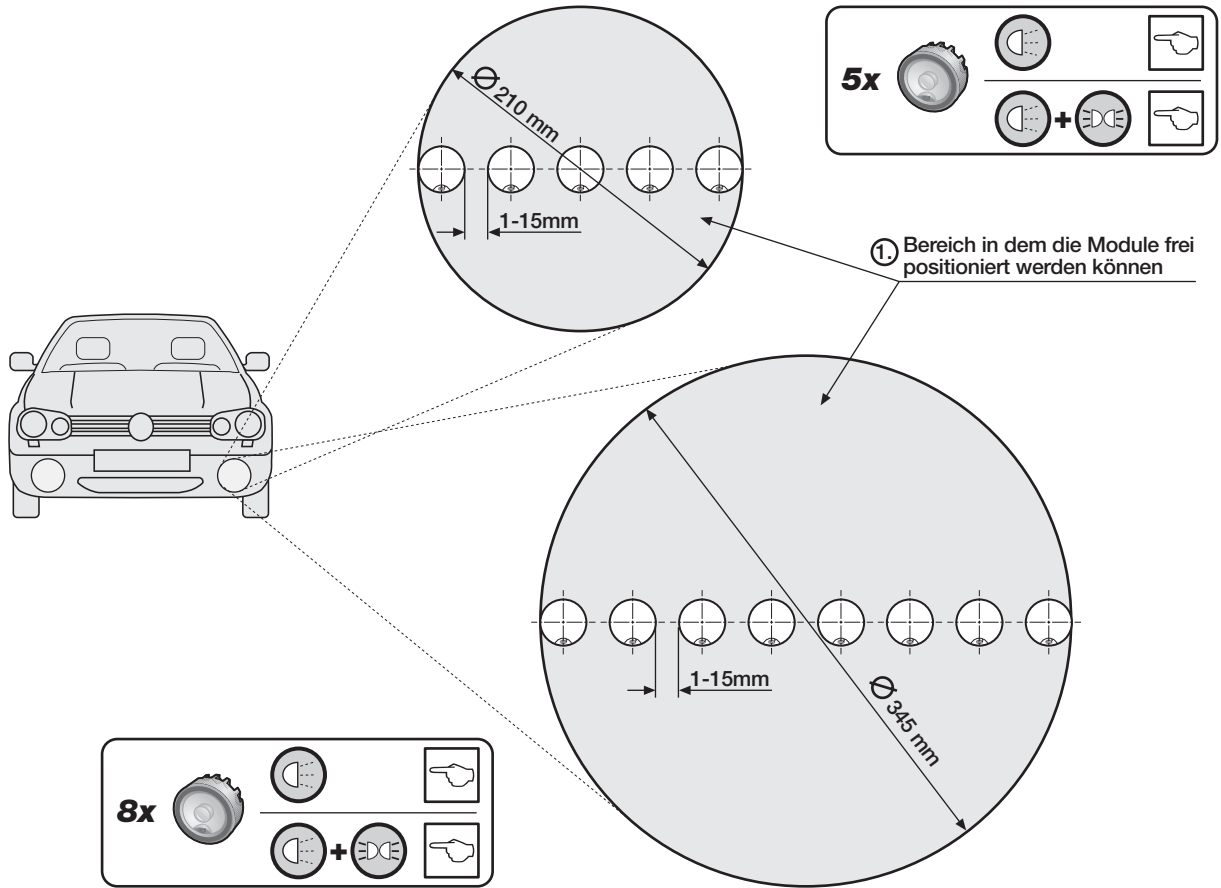

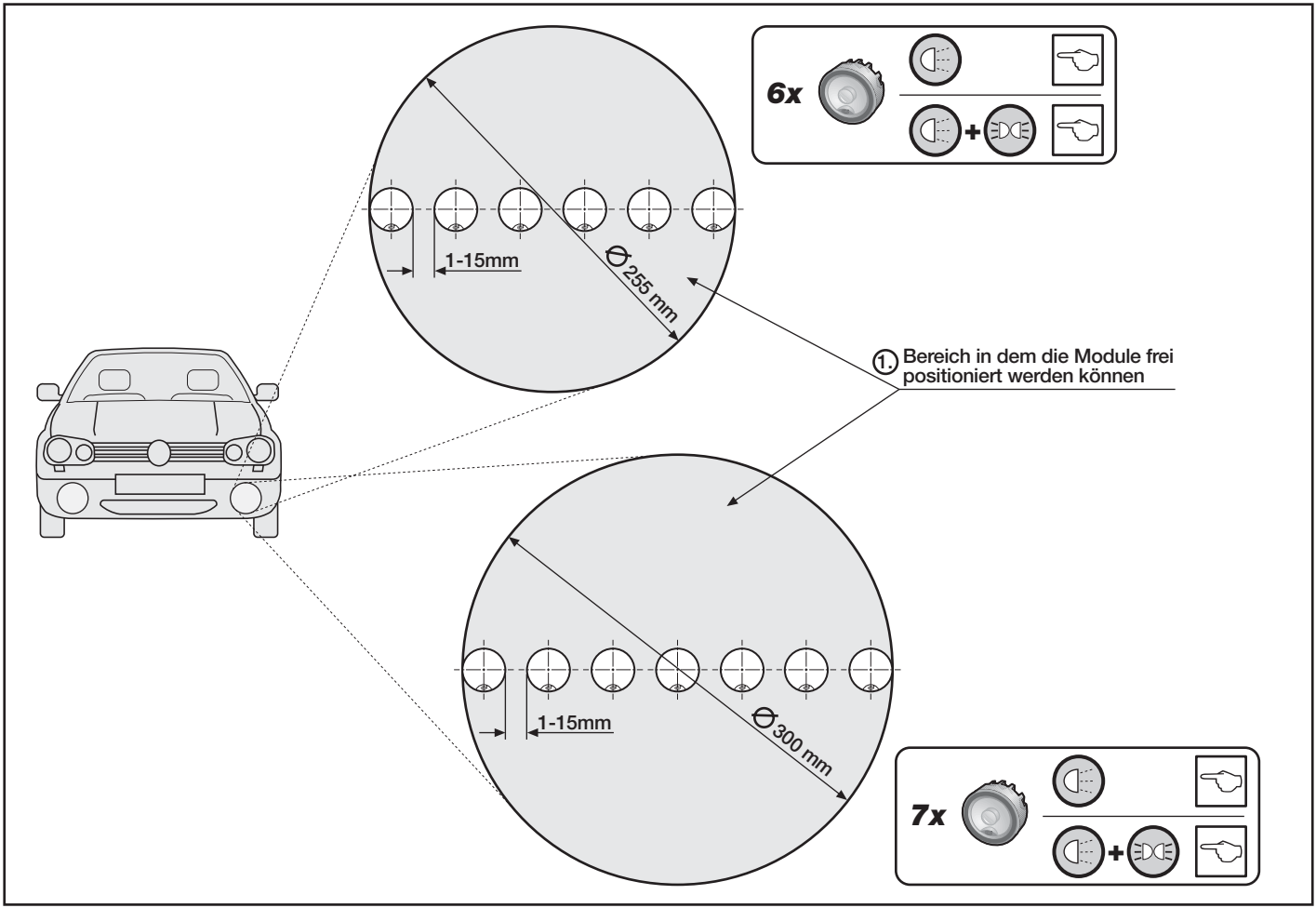

DE ① Bereich in dem die Module frei positioniert werden können

EN ① Area within which the modules can be freely positioned

FR ① Zone dans laquelle le module peut être positionné librement

SV ① Område i vilket modulerna kan placeras fritt

NL ① Bereik waarin de module vrij kan worden gepositioneerd

ES ① Zona en la cual se pueden colocar los módulos libremente



IT ① Area nella quale è possibile disporre liberamente i moduli

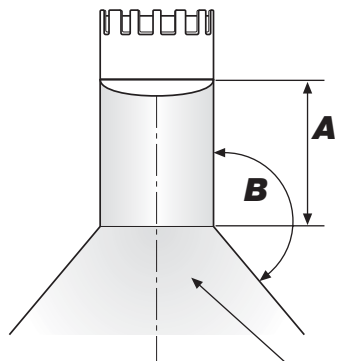

FI ① Alue, jossa moduulit voidaan sijoittaa vapaasti

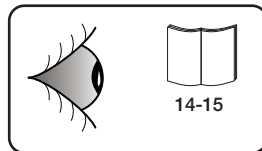
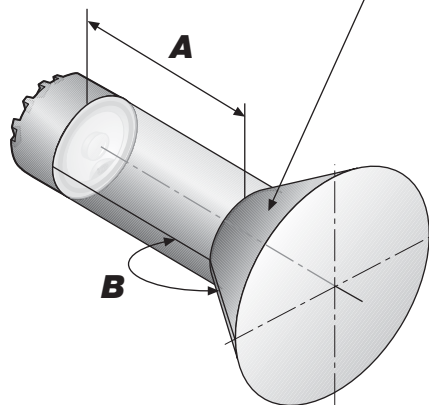





① Innerhalb dieses Bereiches dürfen keine weiteren Module oder andere Bauteile positioniert werden.







5x    **A = 35,8mm, B=140°**



 + 



6x    **A = 38,4mm, B=142°**

 + 

7x    **A = 41,3mm, B=144°**

 + 

8x    **A = 44,5mm, B=146°**

 + 

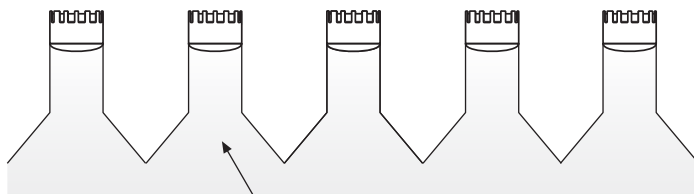

① Innerhalb dieses Bereiches dürfen keine weiteren Module oder andere Bauteile positioniert werden.

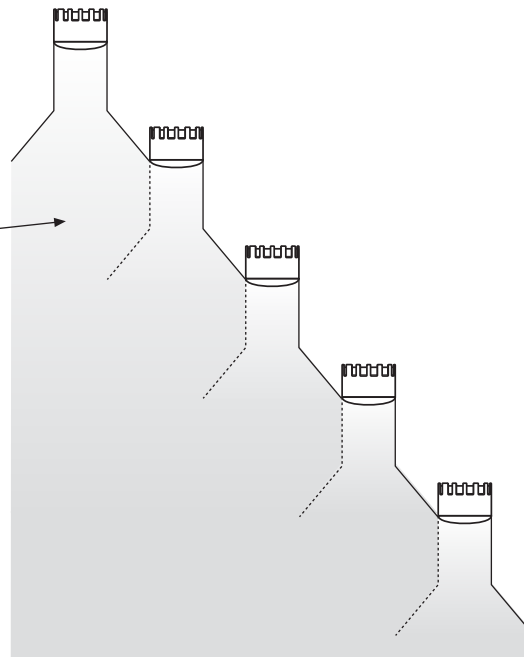
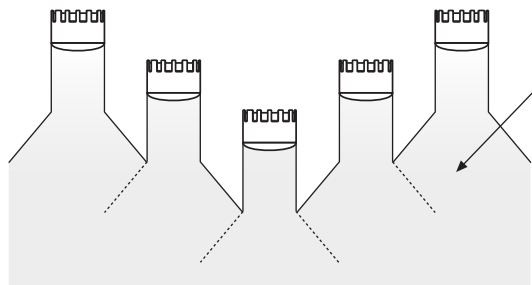

5x
6x
7x
8x



5x
6x
7x
8x

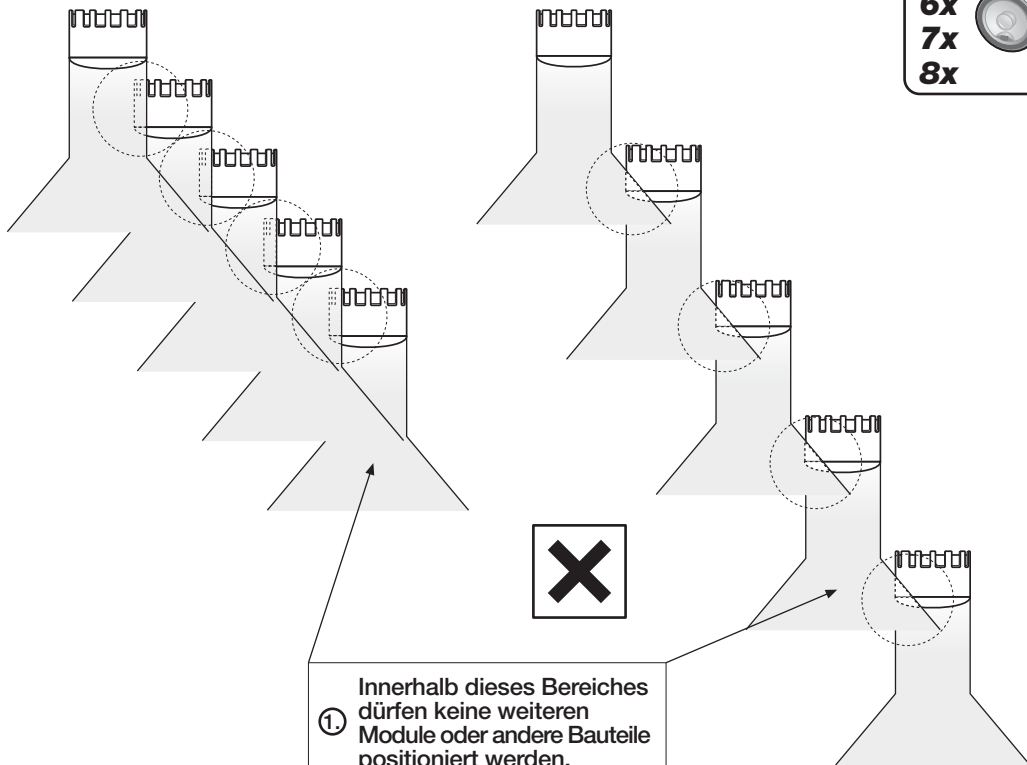

①

Innerhalb dieses Bereiches dürfen keine weiteren Module oder andere Bauteile positioniert werden.

DE ① Innerhalb dieses Bereiches dürfen keine weiteren Module oder andere Bauteile positioniert werden.

EN ① No further modules or other components may be positioned within this area

FR ① Aucun autre module ou élément de construction ne doit être positionné à l'intérieur de cette zone

SV ① Inom detta område får inga andra moduler eller andra komponenter placeras

NL ① Binnen dit bereik mogen er geen andere modules of andere componenten worden gepositioneerd

ES ① Dentro de esta zona no se pueden colocar más módulos u otros componentes

IT ① All'interno di questa area non è possibile posizionare alcun altro modulo o elemento costruttivo

FI ① Tälle alueelle ei saa sijoittaa mitään muita moduuleja tai muita rakenneosia

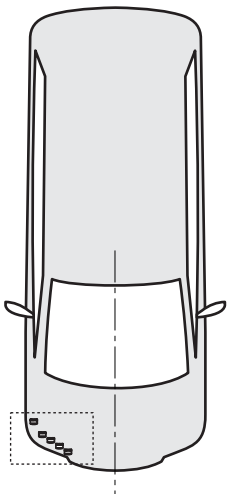
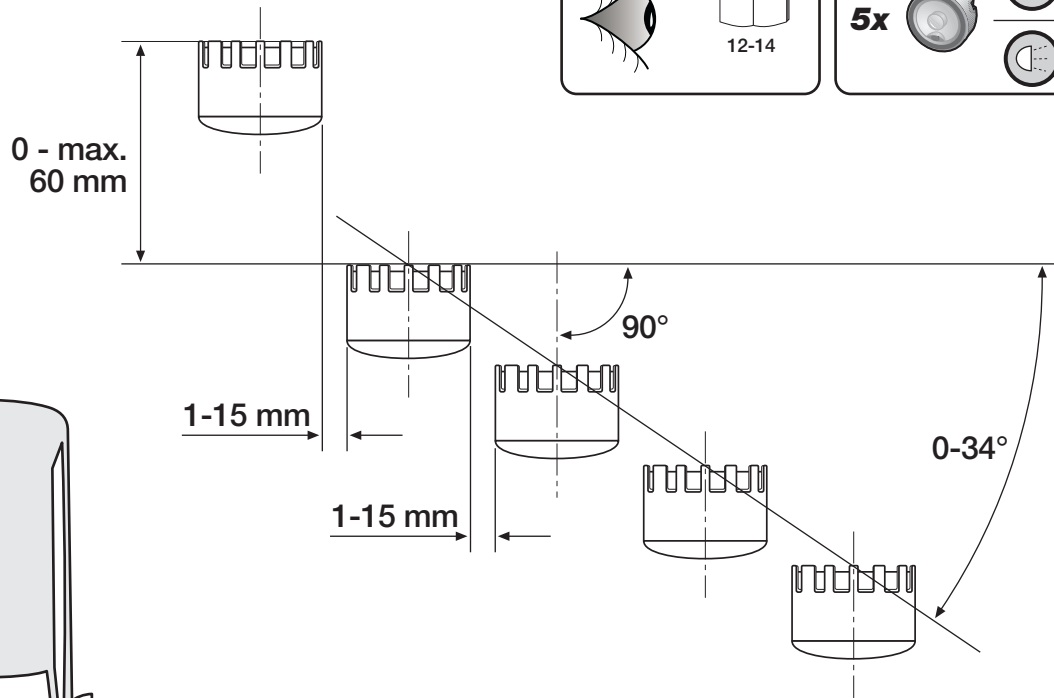
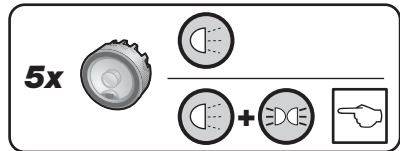
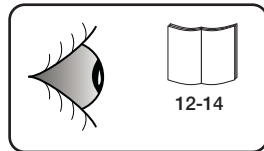

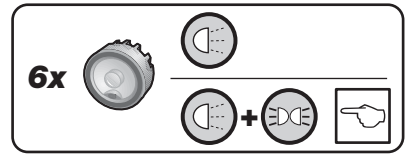
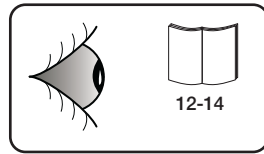

0 - max.
60 mm

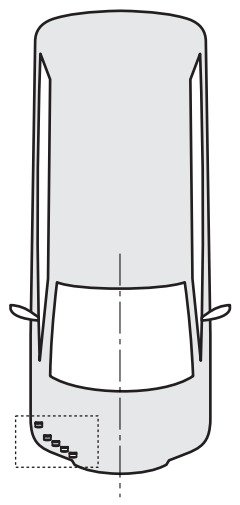
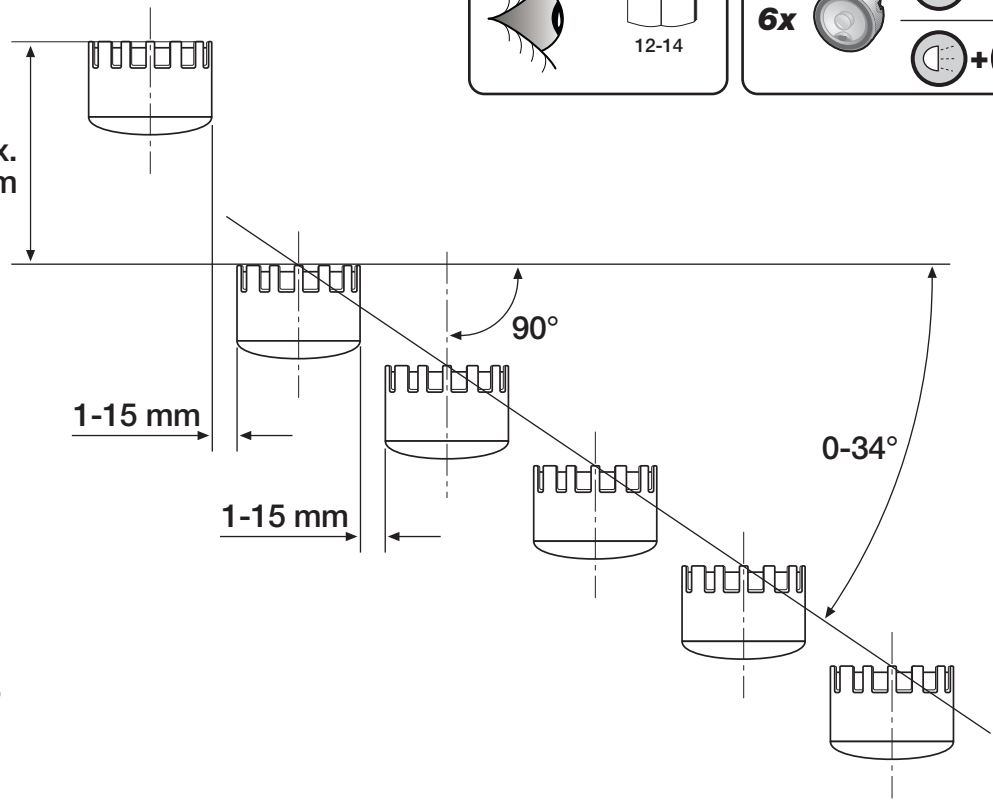

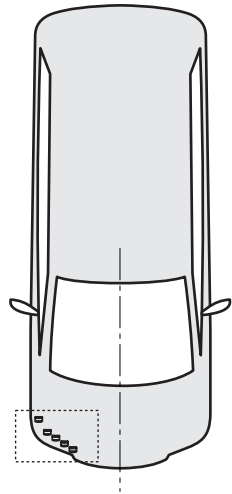
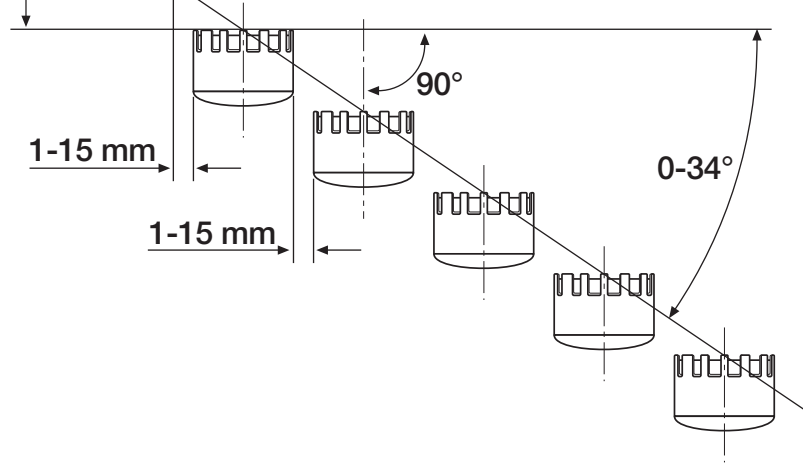
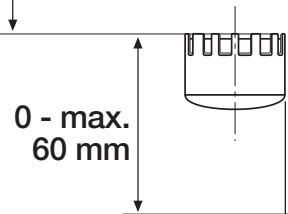
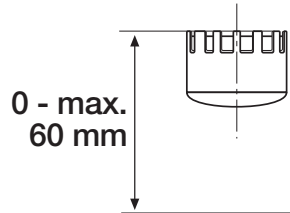
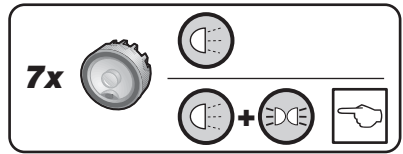
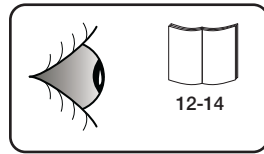

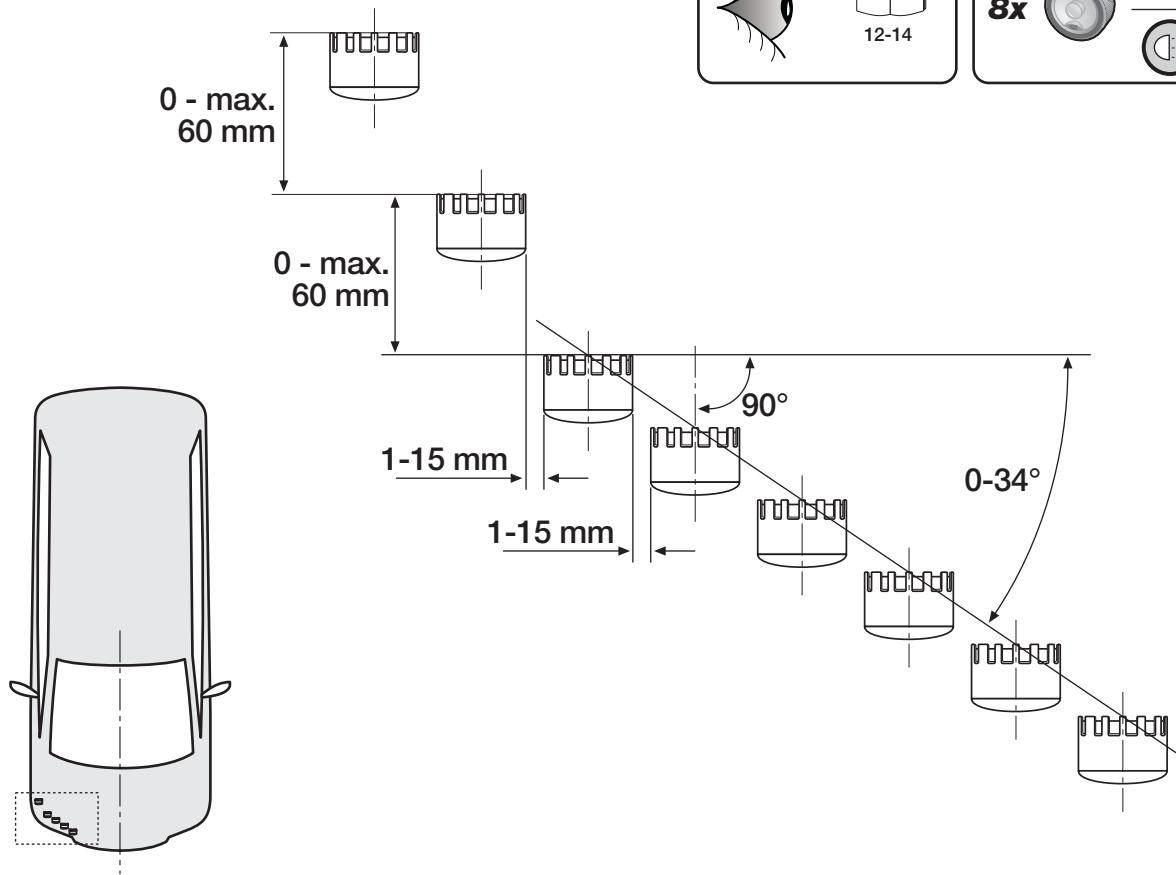
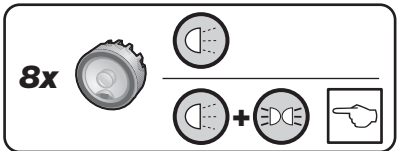
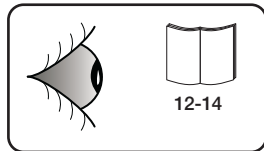

Kombinationsbeispiele
Possible combinations

Combinaisons possibles
Möjlīga grupperingar

Mogelijke groeperingen
Posibles agrupaciones

Possibili raggruppamenti
Mahdolliset ryhmitykset

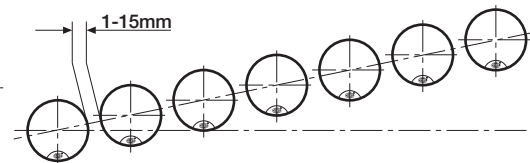
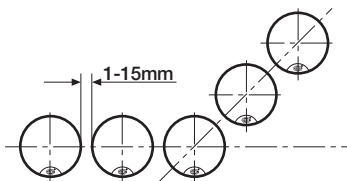
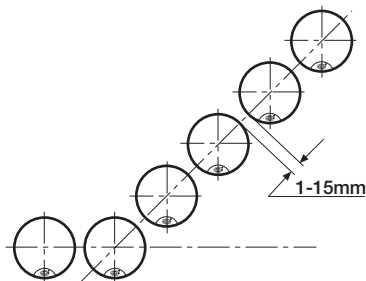
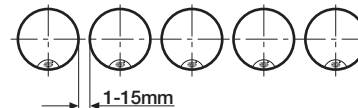
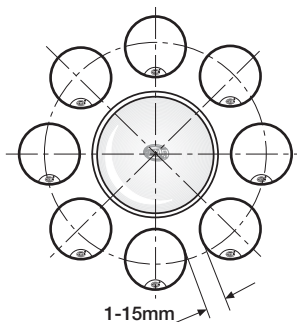
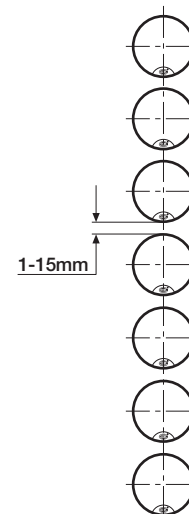
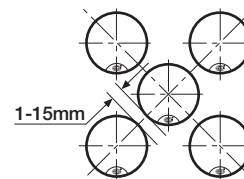
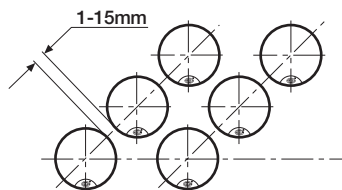
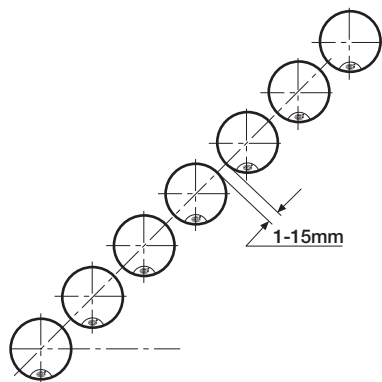

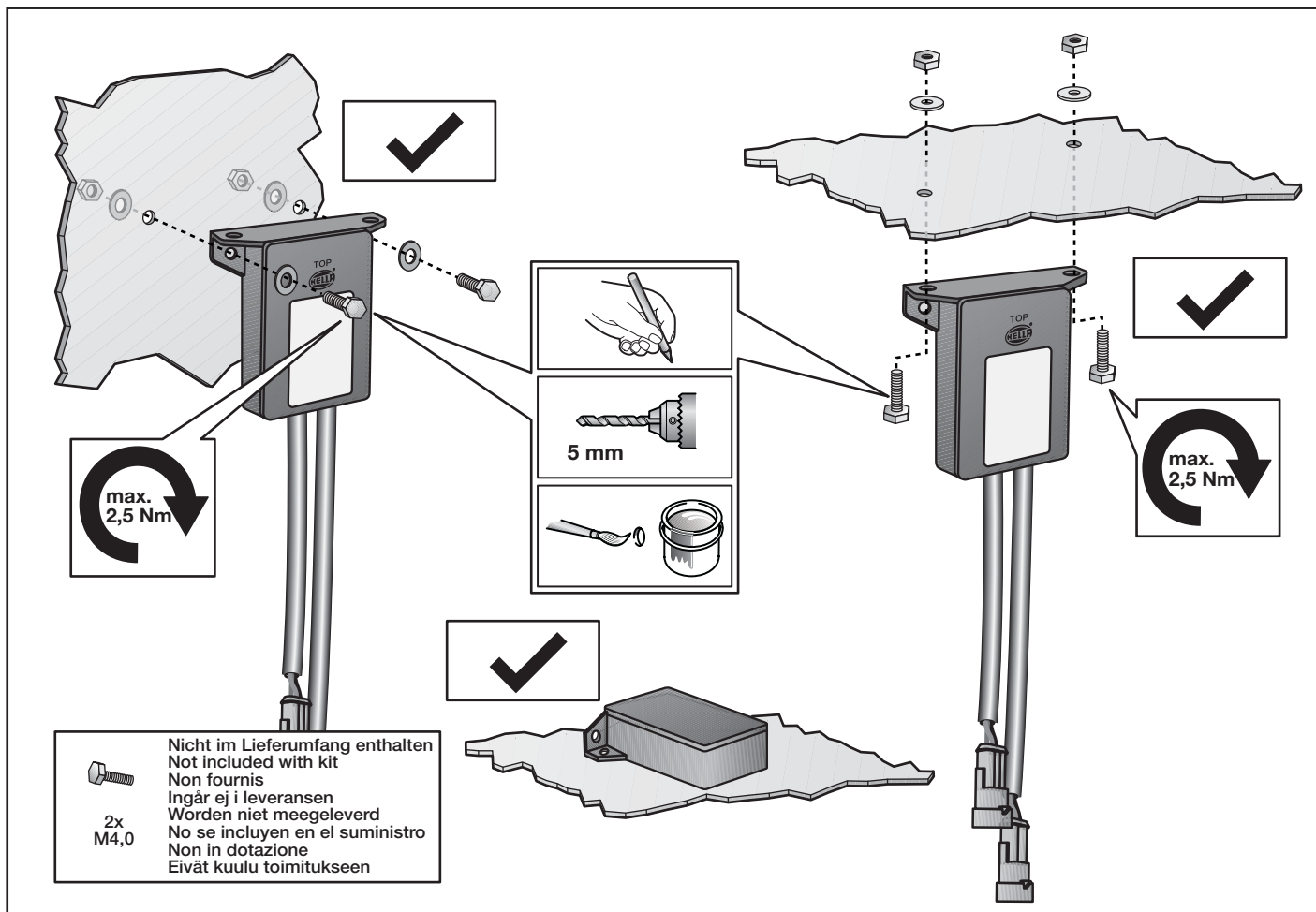

Montagevorschlag
Mounting suggestion

Proposition de montage
Monteringsförslag

Montagevoorstel
Propuesta de montaje

Proposta di montaggio
Asennusehdotus

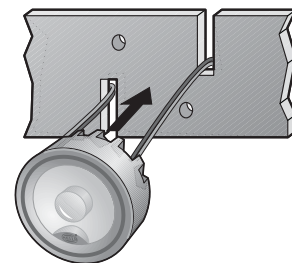
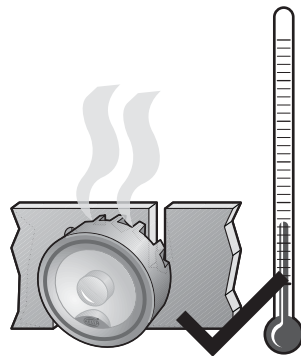
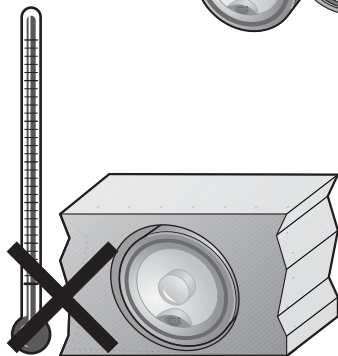
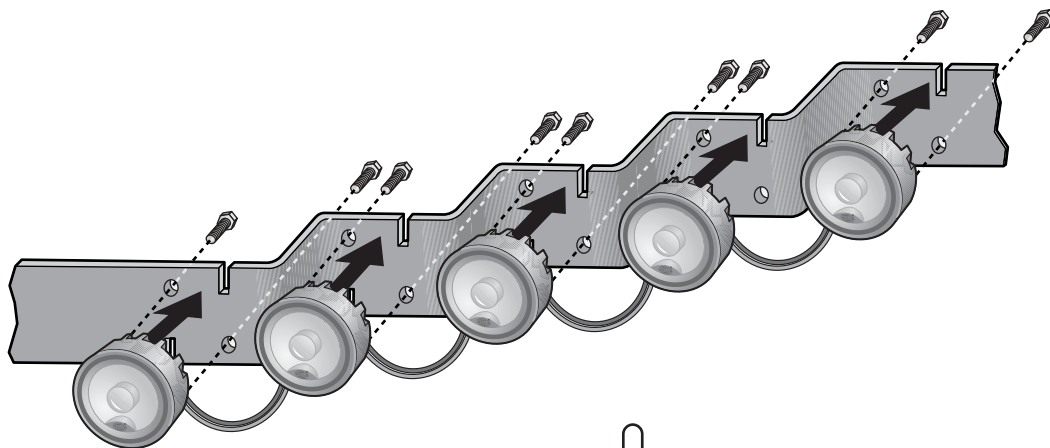

Elektrischer Anschluss
Electrical connection



Connexion électrique
Elektrisk anslutning



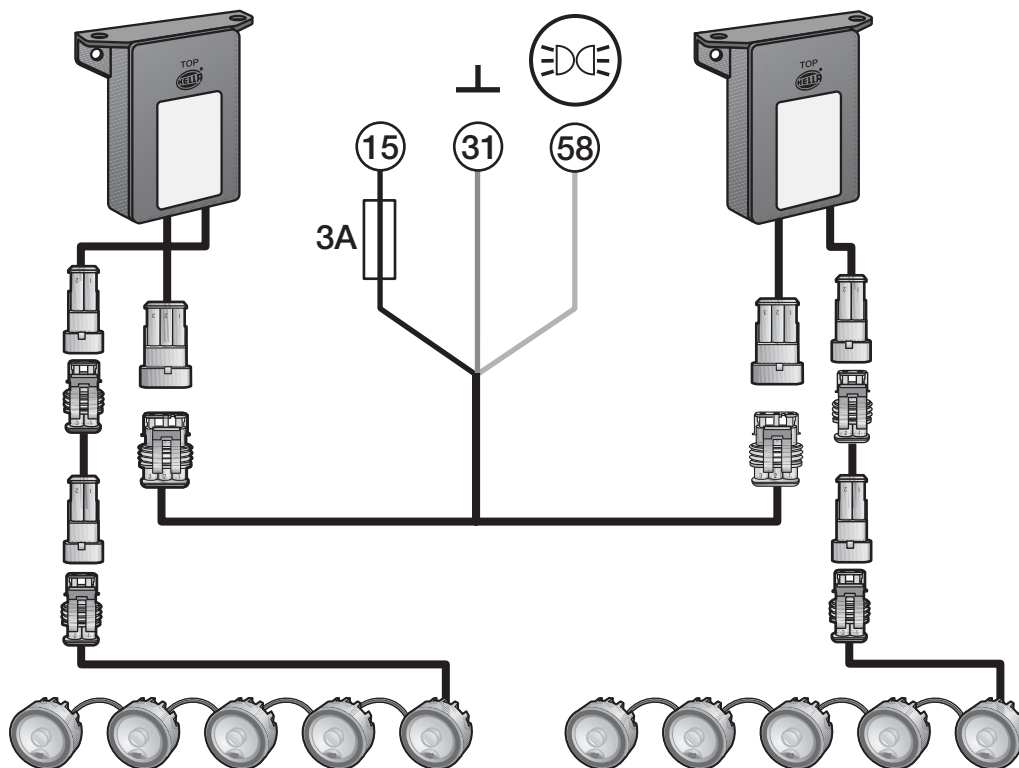

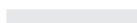

Elektrische aansluiting
Conexión eléctrica

Allacciamento elettrico
Sähköliitäntä



15	schwarz black noir svart	zwart negro nero musta
31	braun brown marron brun	bruin marrón marrone ruskea
58	grau grey gris grå	grijs gris grigio harmaa

15	schwarz black noir svart	zwart negro nero musta	
31	weiss white blanc vit	wit blanco bianco valkoinen	
58	grau grey gris gra	grijs gris grigio harmaa	

5x  
6x  
7x  +  
8x

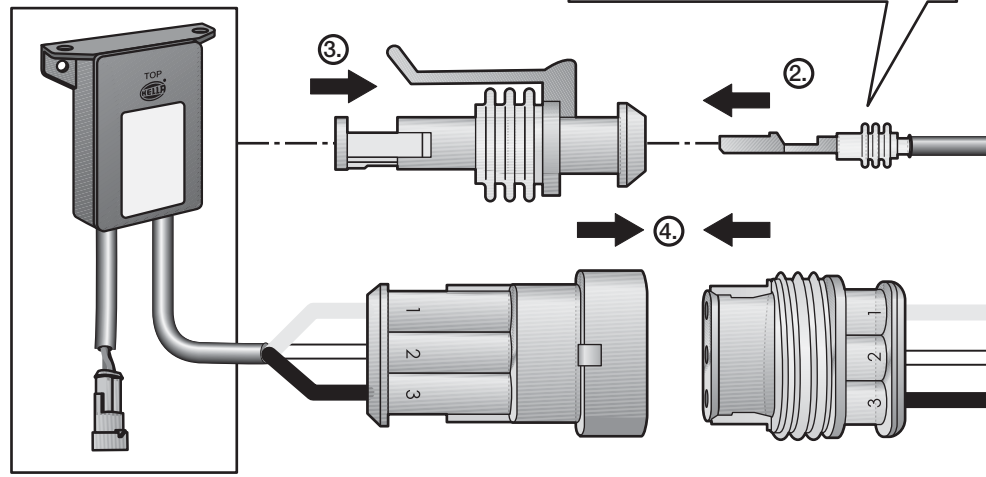
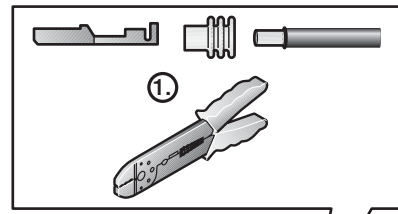

8KW 744 807-801

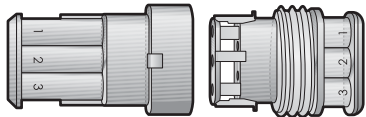









Nicht im Lieferumfang enthalten
Not included with kit
Non fornita
Ingår ej i leveransen
Worden niet meegeleverd
No se incluyen en el suministro
Non in dotazione
Eivät kuulu toimitukseen

15 schwarz zwart
 black negro
 noir nero
 svart musta

31 blau blauw
 blue azul
 bleu blu
 blå sininen

58 grau grijs
 grey gris
 gris grigio
 gra harmaa

5x   
 6x  
 7x  + 
 8x  + 

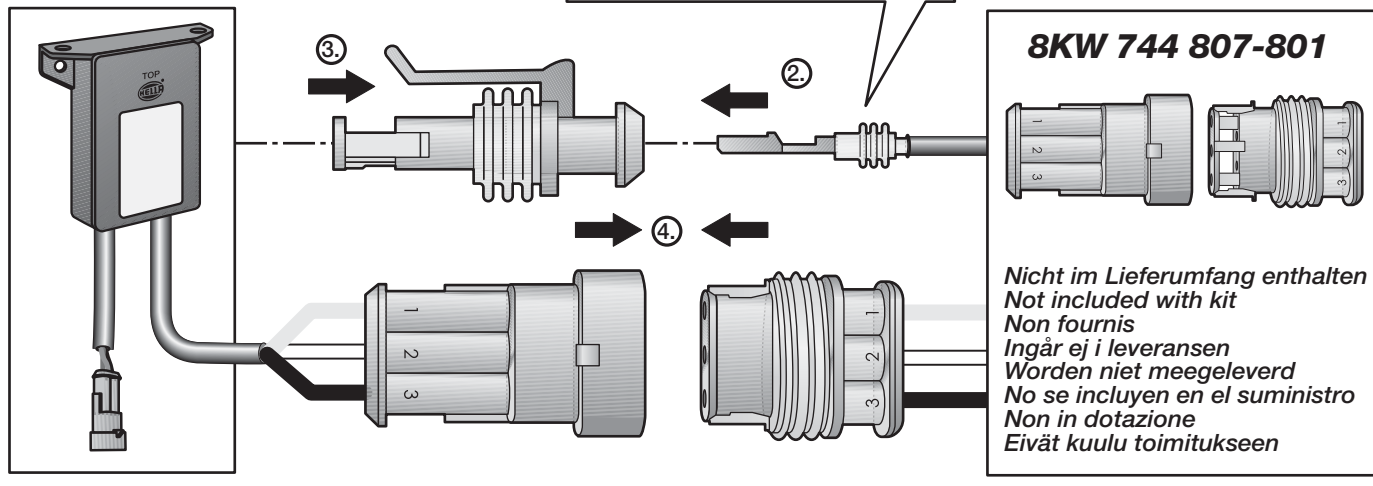
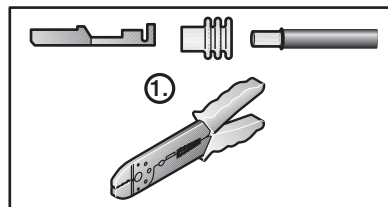

8KW 744 807-801

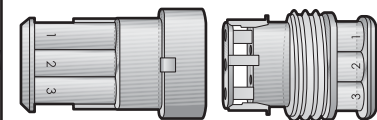

*Nicht im Lieferumfang enthalten
 Not included with kit
 Non fournis
 Ingår ej i leveransen
 Worden niet meegeleverd
 No se incluyen en el suministro
 Non in dotazione
 Eivät kuulu toimitukseen*

DE

Beleuchtungsanlage auf einwandfreie Funktion hin prüfen

EN

Check that the lighting system is working perfectly

FR

Contrôler le bon fonctionnement de l' installation d' éclairage

SV

Kontrollera att ljussystemet fungerar felfritt

NL

Controleer of de verlichting goed functioneert

ES

Comprobar que el sistema de iluminación funciona impecablemente

IT

Controllare la perfetta funzionalità dell' impianto di illuminazione

FI

Tarkasta valaistusjärjestelmän toiminta

DE

Bei Fragen oder Einbauproblemen, rufen Sie bitte den HELLA Kundendienst, Großhändler an oder wenden Sie sich an Ihre Werkstatt.

EN

If you have questions or installation problems, please call the HELLA Service, wholesaler, or turn to your garage.

FR

Pour toutes questions ou problèmes de montage, merci de contacter le service après-vente HELLA, votre distributeur ou votre garage.

SV

Vid frågor eller monteringsproblem, kontakta Hellas kundtjänst, återförsäljaren eller din verkstad.

NL

In geval van vragen of montageproblemen verzoeken wij u contact met de HELLA-klantenservice, de groothandel of uw dealer op te nemen.

ES

En caso de dudas o problemas de montaje, por favor, llame al Servicio postventa de Hella o al mayorista, o bien diríjase a su taller.

IT

Per qualsiasi domanda o problemi di montaggio si prega di contattare il servizio assistenza o il proprio grossista HELLA oppure di rivolgersi alla propria officina.

FI

Jos sinulla on kysymyksiä tai asennusongelmia, soita HELLA-asiakaspalvelulle tai tukkuliikkeelle tai käänny korjaamon puoleen.

DE

Technische Änderungen vorbehalten

Seite **30****EN**

Subject to alteration without notice

Page **31****FR**

Sous réserve de modifications techniques

Page **32****SV**

Vi reserverar oss för tekniska ändringar

Sidan **33****NL**

Technische wijzigingen voorbehouden

Bladzijde **34****ES**

Reservadas modificaciones técnicas

Página **35****IT**

Con riserva modifiche tecniche

Pagina **36****FI**

Oikeus teknisiin muutoksiin pidätetään

Sivu **37**



DEUTSCH

Achtung! Laut ECE R-48 dürfen nur zwei Positionsleuchten, nach vorne, aktiv sein. Soll die Positionslichtfunktion von den LED Leuchten übernommen werden, muss das serienmäßige Positionslicht deaktiviert werden.

Montage Seite 6

- * Bei Verwendung als PO-Licht min. 350 mm.
- ** Bei Fahrzeugen mit einer Breite von < 1300mm muss der Abstand min. 400 mm betragen.
- *** Bei Verwendung als PO-Licht max. 400mm.
Wird die Leuchte nur für die Tagfahrlicht-Funktion eingesetzt, entfällt diese Einschränkung.

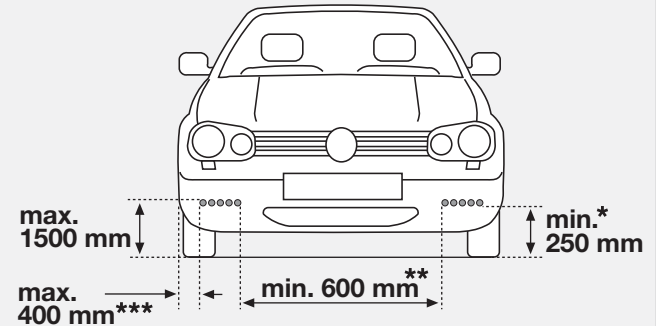

Elektrischer Anschluss Seite 24

Leitungen nach Schaltplan verlegen und anschließen.

Nach Schaltplan werden die Tagfahrleuchten automatisch mit der Zündung eingeschaltet

Achtung!

Tagfahrleuchten:

- sind **kein** Ersatz für Abblendlicht bei Dämmerung oder Dunkelheit.
- leuchten nur bei ausgeschalteter Fahrzeugbeleuchtung und eingeschalteter Zündung.
- schalten sich beim Einschalten der Fahrzeugbeleuchtung automatisch **aus**.
- sind zugelassen gemäß ECE R87.
- dürfen entsprechend der EG-Richtlinie EG R97/28 bzw. ECE R48 angebaut werden.

Wir empfehlen die Montageanleitung mit den KFZ-Papieren mitzuführen.

Note! According to ECE R-48, only two front position lights may be active. If the position light function is to be taken over by the LED lights, the standard position light must be deactivated.

Montage Page 6

- * When used with position light min. 350 mm.
- ** With vehicles less than 1300 mm wide, the distance has to be at least 400 mm.
- *** When used with position light max. 400mm. If the light is only used for the daytime running light function, this restriction does not apply.

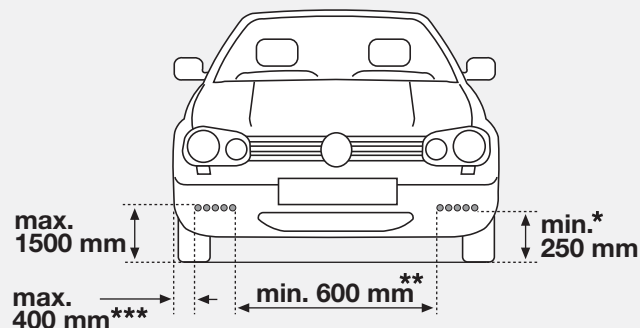

Electrical connection Page 24

Lay and connect the cables in accordance with the connection diagram.

According to the connection diagram, the daytime running lights are switched on automatically with the ignition.

Caution!

Daytime running lights:

- are **not** a substitute for low beam at dawn/dusk or during darkness.
- they shine only when the vehicle lighting is switched off and the ignition is switched on.
- they switch off **automatically** when switching on the vehicle lighting.
- are approved in accordance with ECE R87.
- may be fitted in accordance with EC Directive EC R97/28 and ECE R48.

We recommend that the installation instructions are carried along with the vehicle documentation.

FR FRANÇAIS

IMPORTANT : Selon le règlement ECE R-48, seuls deux feux de position, vers l'avant, peuvent être actifs. Si la fonction de feu de position est assurée par les feux LED, les feux de position de série doivent être désactivés.

Montage Page 6

- * Si utilisé avec la fonction feu de position, minimum 350 mm.
- ** Sur les véhicules d'une largeur <1300 mm, la distance minimale doit être de 400 mm.
- *** Si utilisé avec la fonction feu de position, maximum 400mm. Cette restriction n'est pas applicable si le feu est uniquement utilisé pour la fonction de feu diurne.

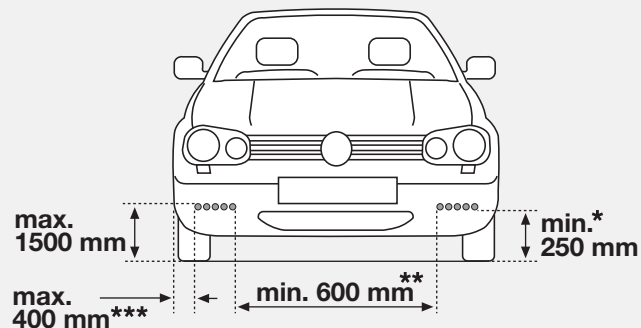

Branchement électrique Page 24

Poser et raccorder les câbles suivant le schéma électrique.

D'après le branchement du schéma électrique, les feux diurnes s'allument automatiquement lors de la mise du contact.

Attention !

Les feux diurnes

- ne remplacent pas les feux de croisement au crépuscule ou dans l'obscurité.
- ils ne s'allument que lorsque l'éclairage du véhicule est coupé et que le contact est mis.
- ils s'éteignent **automatiquement** lorsque l'éclairage du véhicule est activé.
- sont homologués conformément à ECE R87
- peuvent être montés conformément à la directive européenne CE R97/28 et/ou ECE R48.

Nous recommandons de conserver l'instruction de montage avec les papiers du véhicule.

Obs! Enligt ECE-R48 får endast två främre positionsljus vara aktiva. Om positionsljusfunktionen övertas av LED-lamporna måste standardpositionsljusen avaktiveras.

Montering Sidan 6

- * Vid användning med positionsljus, minst 350 mm.
- ** På fordon med en bredd på < 1 300 mm måste avståndet vara minst 400 mm.
- *** Vid användning med positionsljus, max. 400mm.
Om lyktorna endast används för varselljusfunktionen gäller inte denna begränsning.

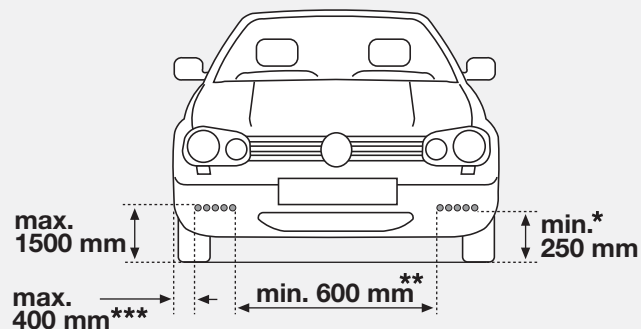

Elektrisk anslutning Page 24

Dra och anslut ledningarna enligt kopplingsschemat.

Enligt kopplingsschemat tänds varselljusen automatiskt när tändningen slås på.

Obs!

Varselljus

- Ersätter inte halvljus vid skymning eller i mörker.
- Är endast tända när fordonsbelysningen är släckt och tändningen har slagits på.
- Släcks **automatiskt** när fordonsbelysningen tänds.
- Är godkända enligt ECE R87.
- Får monteras enligt EU-riktlinje 97/28/EG respektive ECE R48.

Vi rekommenderar att du har med monteringsanvisningen i bilen tillsammans med fordonsdokumenten.

NE NEDERLANDS

Let op! Volgens ECE R-48 mogen slechts twee positielampen, naar voren, actief zijn. Als de LED-lampen de functie van positielicht moeten uitvoeren, moet het standaard positielicht worden uitgeschakeld.

Montage Pagina 6

- * Bij gebruik met positielicht min. 350 mm.
- ** Bij voertuigen met een breedte <1300 mm dient de afstand min. 400 mm te zijn.
- *** Bij gebruik met positielicht max. 400mm. Deze beperking vervalt als de lamp alleen voor de dagrijlichtfunctie wordt gebruikt.

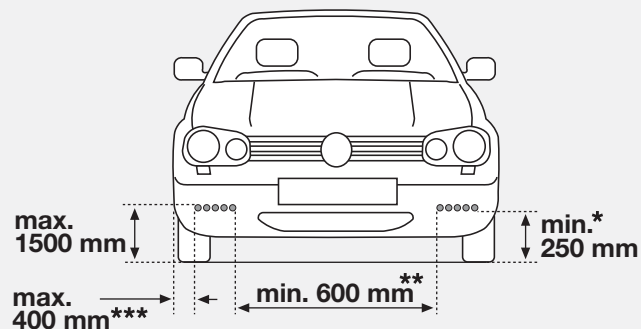

Elektrische aansluiting Pagina 24

Kabels in overeenstemming met schakelschema leggen en aansluiten.

Volgens het schakelschema worden de dagrijlichten automatisch geactiveerd door het omdraaien van de contactsleutel.

Let op!

Dagrijlichten

- zijn bij schemering of duisternis **geen** vervanging voor dimlicht.
 - branden alleen als de voertuigverlichting is uitgeschakeld en het contact is ingeschakeld.
 - schakelen bij het inschakelen van de voertuigverlichting **automatisch** uit.
 - zijn toegelaten volgens ECE R87.
 - mogen volgens de EG-richtlijn EG R97/28 of ECE R48 worden ingebouwd.
- Wij adviseren de montagehandleiding bij de voertuigpapieren te bewaren.**



ESPAÑOL

¡Atención! Según la norma ECE R-48, en el vehículo sólo puede haber dos luces de posición delante activas. En caso de que las luces LED realicen la función de luz de posición, la luz de posición de serie deberá desactivarse.

Montaje *Página 6*

- * Si se utilizan como luz de posición, mínimo 350 mm.
- ** En los vehículos con un ancho inferior a 1.300 mm, la distancia debe ser de 400 mm como mínimo.
- *** Si se utilizan como luz de posición, máximo 400mm. En caso de emplear las lámparas sólo con la función de alumbrado diurno, desaparece esta limitación.

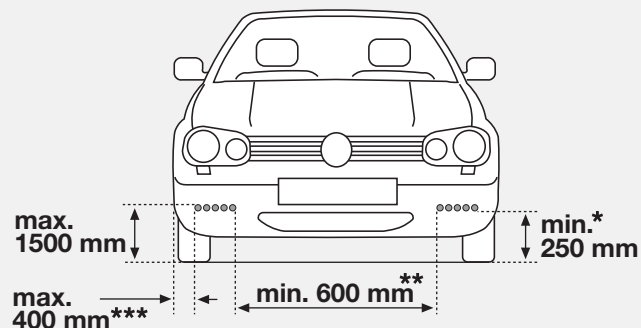

Conexión eléctrica *Página 24*

Tender y conectar los cables según el esquema de conexiones. Según el esquema de conexiones, los faros diurnos se encienden automáticamente al arrancar el vehículo.

¡Atención!

Faros diurnos

- **No** sustituyen la luz de cruce al atardecer o durante las horas nocturnas.
- Sólo se encienden cuando la iluminación del vehículo está apagada y el encendido está conectado.
- Se desconectan **automáticamente** al encender la iluminación del vehículo.
- Están homologados según la normativa CEE R87.
- Pueden montarse según la directriz europea CE R97/28 o CEE R48.

Recomendamos llevar las instrucciones de montaje junto con los papeles del vehículo.

IT ITALIANO

Attenzione! Secondo la norma ECE R-48 nella parte frontale possono essere attive solo due luci di posizione. Se la funzione luci di posizione è realizzata dai fanali a LED, si deve disattivare la luce di posizione di serie.

Montaggio Pagina 6

- * In caso di utilizzo con luci di posizione, min. 350 mm.
- ** Per i veicoli con una larghezza < 1300 mm, la distanza min. deve essere di 400 mm.
- *** In caso di utilizzo con luci di posizione, max. 400mm. Se la luce viene inserita solo con funzione di luce di marcia diurna, questa limitazione decade.

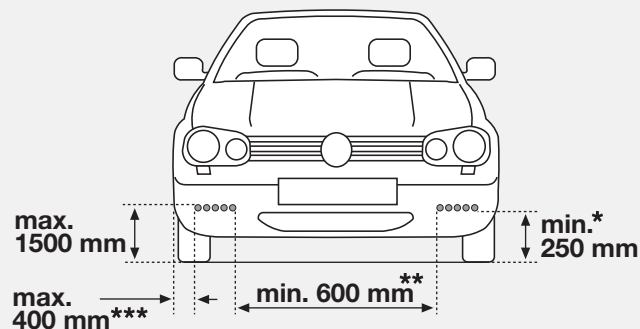

Collegamento elettrico Pagina 24

Posizionare i cavi e collegarli in base allo schema elettrico.

Quando si inserisce l'accensione, le luci di marcia diurna si accendono automaticamente in base allo schema.

Attenzione!

Luci di marcia diurna

- **non** possono essere utilizzate al posto delle luci anabbaglianti al crepuscolo
- o al buio.
- si accendono solo se l'illuminazione del veicolo è disinserita e solo se è stata inserita l'accensione.
- si spengono **automaticamente** attivando l'illuminazione del veicolo.
- sono omologate in base alla normativa ECE R87 devono essere montate in modo conforme alla direttiva CE R97/28 o ECE R48.

Si consiglia di tenere le istruzioni di montaggio con i documenti del veicolo.



SUOMI

Huomio! ECE-standardin R-48 mukaan vain kaksi eteenpäin kohdistettua paikannusvaloa saa olla päällä. Jos toiminto siirtyy LED-valaisimille, vakiovarusteena olevat valot täytyy kytkeä pois päältä.

Asennus sivu 6

- * Seisontavalona käytettynä vähintään 350 mm.
- ** Vähintään 400 mm erillään toisistaan, jos ajoneuvon leveys on < 1.300 mm.
- *** Seisontavalona käytettynä maks. 400mm. Tämä rajoitus raukeaa, jos valoa käytetään vain huomiovalona.

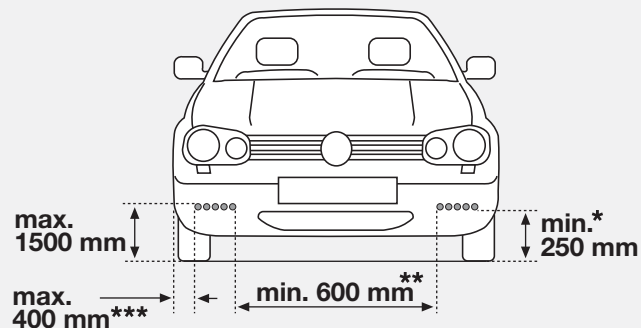

Sähköinen liitäntä sivu 24

Asenna johdot kytkentäkaavion mukaan ja liitä.

Kytkentäkaavion mukaan huomiovalot syttyvät automaattisesti virta-avainta käännettäessä.

Huomio!

Huomiovalot

- **eivät** korvaa lähivaloja hämärällä tai pimeällä ajettaessa.
 - palavat vain, kun sytytys on päällä ja ajovalot pois päältä.
 - sammuvat **automaattisesti**, kun ajovalot kytketään päälle.
 - ECE R87-hyväksyntä
 - pinta-asennus sallittu EY-ohjesäännön R97/28 tai ECE-standardin R48 mukaan.
- Suosittelimme asennusohjeen kuljettamista ajoneuvopaperien mukana.**



HELLA KGaA Hueck & Co

Type: 2PT 010 458
Typ: (Version A)

Page 3
Blatt 3

Belongs to approval no.: E24 5852
Gehört zu Gen.-Nr.:

Daytime Running Lamp or Front Position Lamp optionally reciprocally incorporated for Automobile.
Tagfahrleuchte oder Begrenzungsleuchte wahlweise ineinandergebaut für Kraftfahrzeuge.

Light source(s):
Lichtquelle(n):

Daytime Running Lamp:
Tagfahrleuchte:

5 LEDs*

Design voltage:
Prüfspannung:

13.5 V / 28.0 V

Nominal power:
Nennleistung:

7.2 W

Front Position Lamp:
Begrenzungsleuchte:

5 LEDs*

12.0 V / 24.0 V

0.6 W

* **The failure of one LED is compensated by upper current supply.**
Der Ausfall einer LED wird durch höhere Stromzufuhr kompensiert.

 = **Centre of reference in accordance with the ECE-Regulations-No. 7 and 87.**
Bezugspunkt nach den ECE-Regelungen-Nr. 7 und 87.

Axis of reference: Parallel to the car centre line and parallel to the road.
Bezugsachse: Parallel zur Fahrzeuglängsachse und parallel zur Fahrbahn.

The reference axis of all single modules must be adjusted parallel to the axis of the driving direction. In the front-view the position of the modules must be defined independently within a circle with a diameter of 210mm. The distance between the edges of the outer lenses of the single modules may be selected up to 15mm within the front-view.

Die Bezugsachse der einzelnen Module müssen immer zur Fahrtrichtung nach vorn ausgerichtet werden. Die Anordnung der einzelnen Module kann in der Vorderansicht kann frei in einem Kreis Ø 210mm gewählt werden. Hierbei kann der Abstand zwischen den Außenkanten der Abschluss-Scheiben der einzelnen Modulen in der Vorderansicht bis 15mm gewählt werden.

X = up to / bis 15mm
Y = Ø 30mm

Front-view
(Ansicht von vorn)

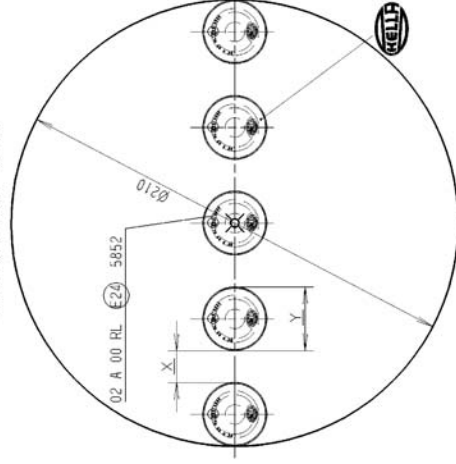

For some installation conditions the visibility angles are asymmetrical with regard to the reference axis in a horizontal direction; in these cases point 4.2.2.5 of the regulation shall be applied for front position lamp.
Für einige Installationsbedingungen wird der Winkel der Sichtbarkeit zur Bezugsachse in horizontaler Richtung asymmetrisch, in diesen Fällen findet für die Begrenzungsleuchte Pkt. 4.2.2.5. der Regelung Anwendung.

The device must be mounted according to the enclosed fitting documents (e. g. sketch + Annex A).
Der An- bzw. Einbau der Geräte hat nach anliegenden An- bzw. Einbauunterlagen (z. B. Skizze und Anlage A) zu erfolgen.

2009-11-20

	Type: <i>Typ:</i>	2PT 010 458 (Version A)	Page 4 <i>Blatt 4</i>
--	-----------------------------	-----------------------------------	---------------------------------

HELLA KGaA Hueck & Co

Belongs to approval no.: E24 5852
Gehört zu Gen.-Nr.:

Daytime Running Lamp or Front Position Lamp optionally reciprocally incorporated for Automobile.
Tagfahrleuchte oder Begrenzungsleuchte wahlweise ineinandergebaut für Kraftfahrzeuge.

Top View -A-
(Ansicht von oben -A-)

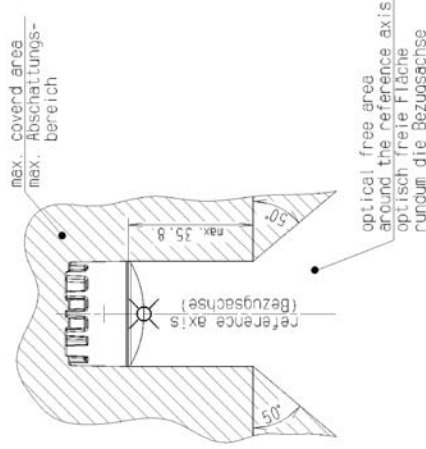

Only for Daytime Running Lamp:

In any possible section through the axis of the unit the single modules may have an offset, described by sketch -A-, showing the maximum covering effects.

Nur für Tagfahrleuchte

In jedem beliebigen Schnitt durch die Bezugsachse des Gerätes dürfen die Module einen Versatz zueinander aufweisen, der durch die max. Abschattungsbedingungen in der Skizze -A- dargestellt wird.

For Daytime Running- and Front Position Lamp:

In any possible section all single modules may be mounted with an offset described by an angle up to 34° to the outer side of the vehicle. The module positioned very outside may have an offset of max 60mm in the top view.

(Details see Top-view -B-)

Für Tagfahr- und Begrenzungsleuchte

Die einzelnen LED-Module dürfen von der Fahrzeuginnenseite um einen Winkel bis 34° nach hinten versetzt zur Fahrzeugaußenseite angebaut werden. Zusätzlich kann das äußerste LED-Modul um max. 60mm zur angrenzenden LED nach hinten versetzt angebaut werden.

(Siehe Ansicht von oben -B-)

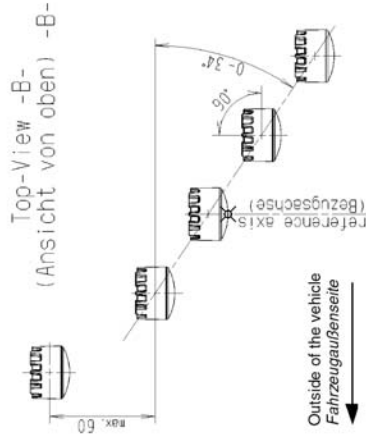

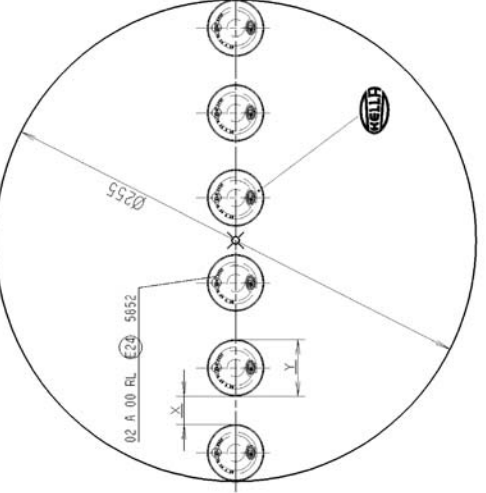
 <p>HELLA KGaA Hueck & Co Gehört zu Gen.-Nr.:</p>	<p>Type: Typ: E24 5852</p> <p>2PT 010 458 (Version B)</p>	<p>Page 5 Blatt 5</p>
<p>Belongs to approval no.: E24 5852</p>		
<p>Daytime Running Lamp or Front Position Lamp optionally reciprocally incorporated for Automobiles. <i>Tagfahrleuchte oder Begrenzungsleuchte wahlweise ineinandergebaust für Kraftfahrzeuge.</i></p>		
<p>Light source(s): <i>Lightquelle(n):</i></p>	<p>Design voltage: Prüfspannung:</p>	<p>Nominal power: Nennleistung:</p>
<p>Daytime Running Lamp: <i>Tagfahrleuchte:</i></p>	<p>13.5 V / 28.0 V</p>	<p>7.2 W</p>
<p>Front Position Lamp: <i>Begrenzungsleuchte:</i></p>	<p>13.5 V / 28.0 V</p>	<p>0.6 W</p>
<p>* The failure of one LED is compensated by upper current supply. <i>Der Ausfall einer LED wird durch höhere Stromzuluhr kompensiert.</i></p>		
<p>☞ = Centre of reference in accordance with the ECE-Regulations-No. 7 and 87. <i>Bezugspunkt nach den ECE-Regelungen-Nr. 7 und 87.</i></p>		
<p>Axis of reference: Parallel to the car centre line and parallel to the road. <i>Bezugsachse: Parallel zur Fahrzeuglängsachse und parallel zur Fahrbahn.</i></p>		
<p>The reference axis of all single modules must be adjusted parallel to the axis of the driving direction. In the front-view the position of the modules must be defined independently within a circle with a diameter of 255mm. The distance between the edges of the outer lenses of the single modules may be selected up to 15mm within the front-view.</p>		
<p><i>Die Bezugsachse der einzelnen Module müssen immer zur Fahrtrichtung nach vorn ausgerichtet werden. Die Anordnung der einzelnen Module kann in der Vorderansicht kann frei in einem Kreis Ø 255mm gewählt werden. Hierbei kann der Abstand zwischen den Aussenkanten der Abschluss-Scheiben der einzelnen Modulen in der Vorderansicht bis 15mm gewählt werden.</i></p>		
<p>X = up to / bis 15mm Y = Ø 30mm</p>		
<p style="text-align: center;">Front-View (Ansicht von vorn)</p> 		
<p>For some installation conditions the visibility angles are asymmetrical with regard to the reference axis in a horizontal direction; in these cases point 4.2.2.5 of the regulation shall be applied for front position lamp. <i>Für einige Installationsbedingungen wird der Winkel der Sichtbarkeit zur Bezugsachse in horizontaler Richtung asymmetrisch; in diesen Fällen findet für die Begrenzungsleuchte Pkt. 4.2.2.5. der Regelung Anwendung.</i></p>		
<p>The device must be mounted according to the enclosed fitting documents (e. g. sketch + Annex A). <i>Der An- bzw. Einbau der Geräte hat nach anliegenden An- bzw. Einbauunterlagen (z. B. Skizze und Anlage A) zu erfolgen.</i></p>		

 HELLA KGaA Hueck & Co	Type: <i>Typ:</i>	2PT 010 458 (Version B)	Page 6 <i>Blatt 6</i>
---	-----------------------------	-----------------------------------	---------------------------------

Belongs to approval no.: E24 5852
Gehört zu Gen.-Nr.:

Daytime Running Lamp or Front Position Lamp optionally reciprocally incorporated for Automobile.
Tagfahrleuchte oder Begrenzungsleuchte wahlweise ineinandergebaut für Kraftfahrzeuge.

Only for Daytime Running Lamp:
 In any possible section through the axis of the unit the single modules may have an offset, described by sketch -A-, showing the maximum covering effects.

Nur für Tagfahrleuchte
 In jedem beliebigen Schnitt durch die Bezugsachse des Gerätes dürfen die Module einen Versatz zueinander aufweisen, der durch die max. Abschattungsbedingungen in der Skizze -A- dargestellt wird.

Top View -A-
 (Ansicht von oben -A-)

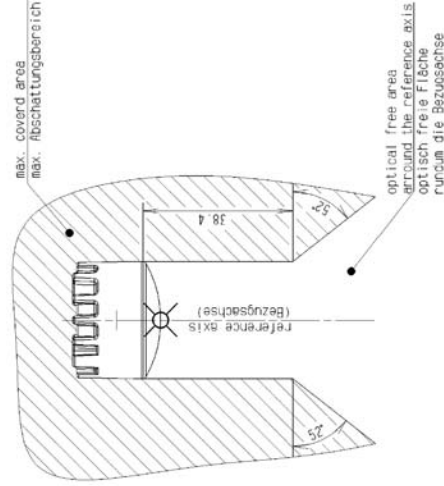



For Daytime Running- and Front Position Lamp:
 In any possible section all single modules may be mounted with an offset described by an angle up to 34° to the outer side of the vehicle. The module positioned very outside may have an offset of max 60mm in the top view.
 (Details see Top-view -B-)

Für Tagfahr- und Begrenzungsleuchte
 Die einzelnen LED-Module dürfen von der Fahrzeuginnenseite um einen Winkel bis 34° nach hinten versetzt zur Fahrzeugaußenseite angebaut werden. Zusätzlich kann das äußerste LED-Modul um max. 60mm zur angrenzenden LED nach hinten versetzt angebaut werden.
 (Siehe Ansicht von oben -B-)

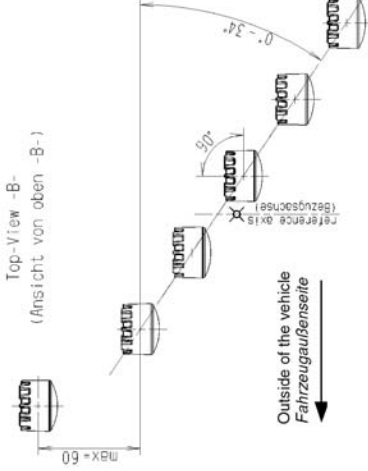
Top-View -B-
 (Ansicht von oben -B-)

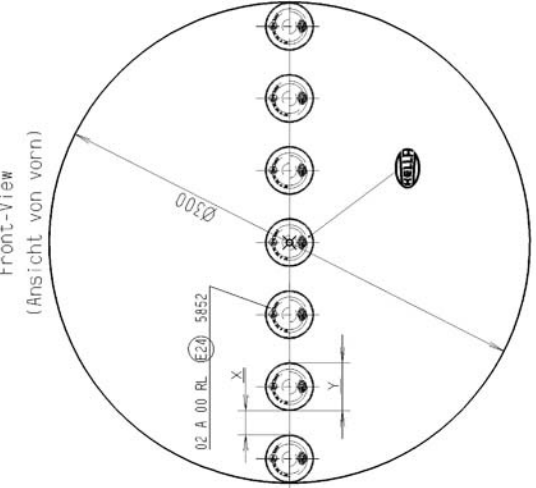

 HELLA KGaA Hueck & Co	Type: <i>Typ:</i> 2PT 010 458 (Version C)	Page 7 <i>Blatt 7</i>
Belongs to approval no.: E24 5852 <i>Geht zu Gen.-Nr.:</i>		
Daytime Running Lamp or Front Position Lamp optionally reciprocally incorporated for Automobile. <i>Tagfahrleuchte oder Begrenzungsleuchte wahlweise ineinandergebaut für Kraftfahrzeuge.</i>		
Light source(s): <i>Leichtquelle(n):</i>	Design voltage: <i>Prüfspannung:</i>	Nominal power: <i>Nennleistung:</i>
Daytime Running Lamp: <i>Tagfahrleuchte:</i>	13.5 V / 28.0 V	7.2 W
Front Position Lamp: <i>Begrenzungsleuchte:</i>	13.5 V / 28.0 V	0.6 W
* The failure of one LED is compensated by upper current supply. <i>Der Ausfall einer LED wird durch höhere Stromzufuhr kompensiert.</i>		
 = Centre of reference in accordance with the ECE-Regulations-No. 7 and 87. <i>Bezugspunkt nach den ECE-Regelungen-Nr. 7 und 87.</i>		
Axis of reference: Parallel to the car centre line and parallel to the road. <i>Bezugsachse: Parallel zur Fahrzeuglängsachse und parallel zur Fahrbahn.</i>		
The reference axis of all single modules must be adjusted parallel to the axis of the driving direction. In the front-view the position of the modules must be defined independently within a circle with a diameter of 300mm. The distance between the edges of the outer lenses of the single modules may be selected up to 15mm within the front-view. <i>Die Bezugsachse der einzelnen Module müssen immer zur Fahrtrichtung nach vorn ausgerichtet werden. Die Anordnung der einzelnen Module kann in der Vorderansicht kann frei in einem Kreis Ø 300mm gewählt werden. Hierbei kann der Abstand zwischen den Außenkanten der Abschluss-Scheiben der einzelnen Modulen in der Vorderansicht bis 15mm gewählt werden.</i>		
X = up to / bis 15mm Y = Ø 300mm		
		
For some installation conditions the visibility angles are asymmetrical with regard to the reference axis in a horizontal direction; in these cases point 4.2.2.5 of the regulation shall be applied for front position lamp. <i>Für einige Installationsbedingungen wird der Winkel der Sichtbarkeit zur Bezugsachse in horizontaler Richtung asymmetrisch; in diesen Fällen findet für die Begrenzungsleuchte Pkt. 4.2.2.5. der Regelung Anwendung.</i>		
The device must be mounted according to the enclosed fitting documents (e. g. sketch + Annex A). <i>Der An- bzw. Einbau der Geräte hat nach anliegenden An- bzw. Einbauunterlagen (z. B. Skizze und Anlage A) zu erfolgen.</i>		



HELLA KGaA Hueck & Co

2PT 010 458
(Version C)

Type:
Typ:

E24 5852

Page 8
Blatt 8

Belongs to approval no.:
Gehört zu Gen.-Nr.:

Daytime Running Lamp or Front Position Lamp optionally reciprocally incorporated for Automobile.
Tagfahrleuchte oder Begrenzungsleuchte wahlweise ineinandergebaut für Kraftfahrzeuge.

Top View -A-
(Ansicht von oben -A-)

Only for Daytime Running Lamp:
In any possible section through the axis of the unit the single modules may have an offset, described by sketch -A-, showing the maximum covering effects.

Nur für Tagfahrleuchte
In jedem beliebigen Schnitt durch die Bezugsachse des Gerätes dürfen die Module einen Versatz zueinander aufweisen, der durch die max. Abschattungsbedingungen in der Skizze -A- dargestellt wird.

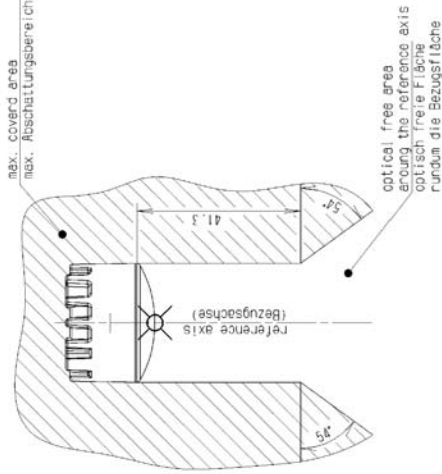

For Daytime Running- and Front Position Lamp:

In any possible section all single modules may be mounted with an offset described by an angle up to 34° to the outer side of the vehicle. The both modules positioned very outside may have an offset of max 60mm in the top view.
(Details see Top-view -B-)

Für Tagfahr- und Begrenzungsleuchte

Die einzelnen LED-Module dürfen von der Fahrzeuginnenseite um einen Winkel bis 34° nach hinten versetzt zur Fahrzeugaußenseite angebaut werden. Zusätzlich können die beiden äußersten LED-Module um max. 60mm zur angrenzenden LED nach hinten versetzt angebaut werden.
(Siehe Ansicht von oben -B-)

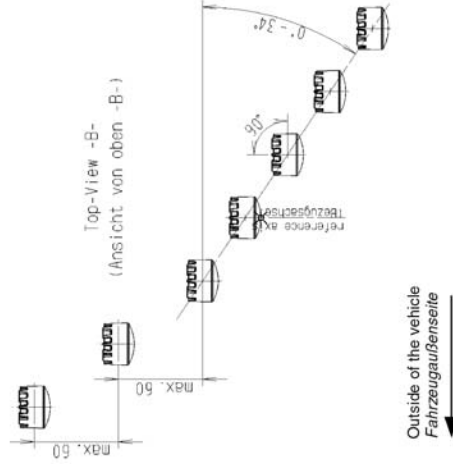

The device must be mounted according to the enclosed fitting documents (e. g. sketch + Annex A).

Der An- bzw. Einbau der Geräte hat nach anliegenden An- bzw. Einbauunterlagen (z. B. Skizze und Anlage A) zu erfolgen.

2009-11-23

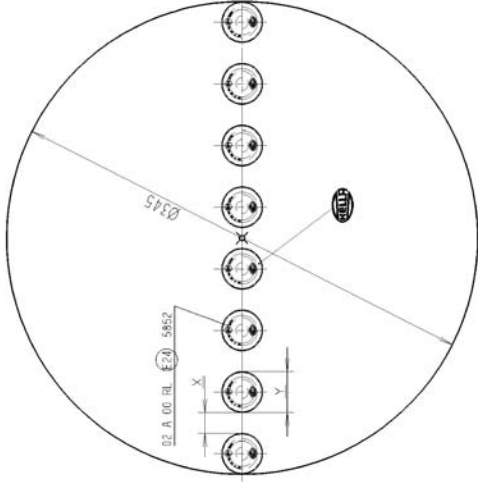
 HELLA KGaA Hueck & Co	Type: <i>Typ:</i> 2PT 010 458 (Version D)	Page 9 Blatt 9
Belongs to approval no.: E24 5852 <i>Gehört zu Gen.-Nr.:</i>		
Daytime Running Lamp or Front Position Lamp optionally reciprocally incorporated for Automobile. <i>Tagfahrleuchte oder Begrenzungsleuchte wahlweise ineinandergebaut für Kraftfahrzeuge.</i>		
Light source(s): <i>Leichtquelle(n):</i>	Design voltage: <i>Prüfspannung:</i>	Nominal voltage: <i>Nennspannung:</i>
Daytime Running Lamp: <i>Tagfahrleuchte:</i>	13.5 V / 28.0 V	12.0 V / 24.0 V
Front Position Lamp: <i>Begrenzungsleuchte:</i>	8 LEDs*	7.2 W
8 LEDs*	13.5 V / 28.0 V	0.6 W
<p>* The failure of one LED is compensated by upper current supply. <i>Der Ausfall einer LED wird durch höhere Stromzufuhr kompensiert.</i></p>		
<p>☉ = Centre of reference in accordance with the ECE-Regulations-No. 7 and 87. <i>Bezugspunkt nach den ECE-Regelungen-Nr. 7 und 87.</i></p>		
<p>Axis of reference: Parallel to the car centre line and parallel to the road. <i>Bezugsachse: Parallel zur Fahrzeuglängsachse und parallel zur Fahrbahn.</i></p>		
<p>The reference axis of all single modules must be adjusted parallel to the axis of the driving direction. In the front-view the position of the modules must be defined independently within a circle with a diameter of 345mm. The distance between the edges of the outer lenses of the single modules may be selected up to 15mm within the front-view. <i>Die Bezugsachse der einzelnen Module müssen immer zur Fahrtrichtung nach vorn ausgerichtet werden. Die Anordnung der einzelnen Module kann in der Vorderansicht kann frei in einem Kreis Ø 345mm gewählt werden. Hierbei kann der Abstand zwischen den Aussenkanten der Abschluss-Scheiben der einzelnen Modulen in der Vorderansicht bis 15mm gewählt werden.</i></p>		
<p>X = up to / bis 15mm Y = Ø 30mm</p>		
 <p style="text-align: center;">Front-View (Ansicht von vorn)</p>		
<p>For some installation conditions the visibility angles are asymmetrical with regard to the reference axis in a horizontal direction; in these cases point 4.2.2.5 of the regulation shall be applied for front position lamp. <i>Für einige Installationsbedingungen wird der Winkel der Sichtbarkeit zur Bezugsachse in horizontaler Richtung asymmetrisch; in diesen Fällen findet für die Begrenzungsleuchte Pkt. 4.2.2.5. der Regelung Anwendung.</i></p>		
<p>The device must be mounted according to the enclosed fitting documents (e. g. sketch + Annex A). <i>Der An- bzw. Einbau der Geräte hat nach anliegenden Anr- bzw. Einbauunterlagen (z. B. Skizze und Anlage A) zu erfolgen.</i></p>		
2009-11-27		



HELLA KGaA Hueck & Co

Type:
Typ: **2PT 010 458**
(Version D)

Page 10
Blatt 10

Belongs to approval no.: E24 5852
Gehört zu Gen.-Nr.:

Daytime Running Lamp or Front Position Lamp optionally reciprocally incorporated for Automobile.
Tagfahrleuchte oder Begrenzungsleuchte wahlweise ineinandergebaut für Kraftfahrzeuge.

Only for Daytime Running Lamp:
In any possible section through the axis of the unit the single modules may have an offset, described by sketch -A-, showing the maximum covering effects.

Nur für Tagfahrleuchte
In jedem beliebigen Schnitt durch die Bezugsachse des Gerätes dürfen die Module einen Versatz zueinander aufweisen, der durch die max. Abschattungsbedingungen in der Skizze -A- dargestellt wird.

Top View -A-
(Ansicht von oben -A-)

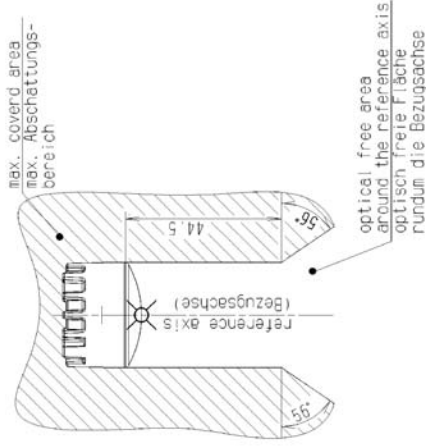

For Daytime Running- and Front Position Lamp:

In any possible section all single modules may be mounted with an offset described by an angle up to 34° to the outer side of the vehicle.

The both modules positioned very outside may have an offset of max 60mm in the top view. (Details see Top-view -B-)

Für Tagfahr- und Begrenzungsleuchte

Die einzelnen LED-Module dürfen von der Fahrzeuginnenseite um einen Winkel bis 34° nach hinten versetzt zur Fahrzeugaußenseite angebaut werden.

Zusätzlich können die beiden äußersten LED-Module um max. 60mm zur angrenzenden LED nach hinten versetzt angebaut werden. (Siehe Ansicht von oben -B-)

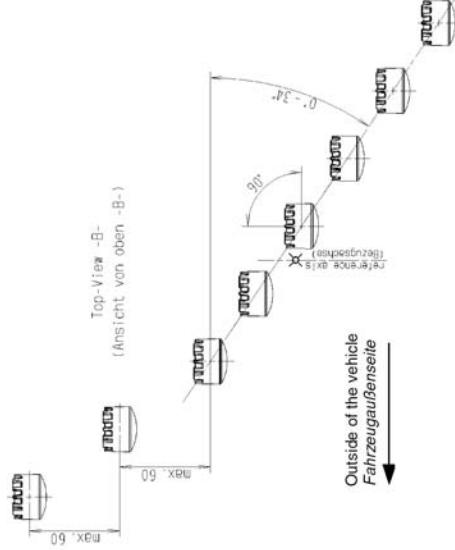

The device must be mounted according to the enclosed fitting documents (e. g. sketch + Annex A).
Der An- bzw. Einbau der Geräte hat nach anliegenden An- bzw. Einbauunterlagen (z. B. Skizze und Anlage A) zu erfolgen.

2009-11-27

Notes

Notes

